

ZH 用户手册 / 组装说明 **2**

EN Instructions for use / Assembly instructions **24**

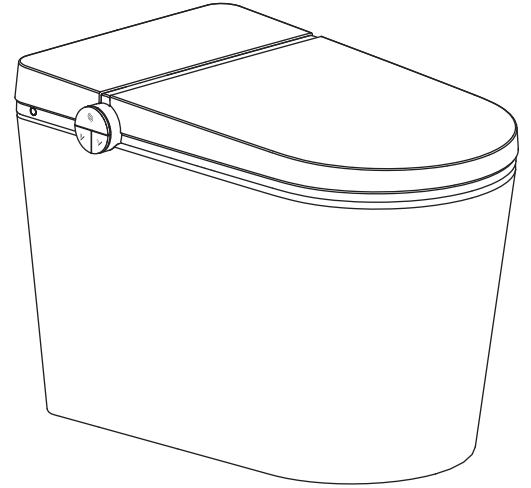

纯境 Element S LavaPura Element S

智能一体坐便器 豪华版305mm
Floorstanding Shower Toilet E 305
22452007

智能一体坐便器 豪华版400mm
Floorstanding Shower Toilet E 400
22453007

智能一体坐便器 舒适版带自动翻盖305mm
Floorstanding Shower Toilet B Autolid 305
22454007

智能一体坐便器 舒适版305mm
Floorstanding Shower Toilet B 305
22455007

智能一体坐便器 舒适版400mm
Floorstanding Shower Toilet B 400
22456007

目录

安 装

安全注意事项	3
所需工具及材料	5
尺寸图	5
技术规格	6
整体简图	7
产品清单	8
安装坐便器	9
安装遥控器	11

使 用 说 明

使用前准备	12
自动开关盖功能	13
本体按键功能	14
遥控器使用方法	14

日 常 保 养

本体的保养	19
遥控器的保养	19
喷嘴的保养	19
清洗过滤网	19
停电停水时	20
长时间不使用时	20

其 他

常见故障诊断和排除	21
电子电气有害物质限制指示表	22
能效水效等级说明	22
产品保修卡	23

安全注意事项



安装前请务必仔细阅读此说明书，并严格按照说明书规定进行安装，阅读后，请将此说明书放在醒目的地方妥善保存。

为了避免使用者和他人受到伤害和财产损失，请严格遵守安全警告和注意事项。



标志及其含义

警告	表示如果不遵守此警告中的规定而误操作时，有可能造成人员重伤或死亡。
注意	表示如果不遵守此注意中的规定而误操作时，有可能造成人身伤害或财产损失。

下列标志是为了表示使用产品时重要安全注意事项而使用的。

标志	说明
	此图表示不可行，【禁止】之意。
	此图表示必须【强制】实行的内容。

警告

	<ul style="list-style-type: none">· 点燃的香烟及其它燃烧物不能投入坐便盖内，否则可能会引起火灾。· 严禁自行拆解、修理或改造产品，否则可能会引起火灾或触电。· 严禁将水或洗涤剂浇于机身或电源插头上，否则可能会引起火灾或触电。· 严禁用湿手触摸电源插头，否则可能会引起触电。· 严禁在同一插座上使用其他电器。· 严禁使用电源延长线或松脱不稳的电源插座，否则可能会引起火灾或触电。· 如果电源软线损坏，为了避免危险，必须专业人员更换。· 本产品属电器类产品，禁止置于易被水淋到的地方。· 请勿用手指或其他物品放入或者堵塞暖风出风口，否则可能会引起烫伤、触电或烧毁。· 产品通电时，不得将产品侧放或倒置，否则可能会引起火灾或烧毁。 请勿在浴室等潮湿的地方安装使用本产品。
	<ul style="list-style-type: none">· 本产品必须可靠接地，且需确保交流插座有接地保护，接地线应使用三脚插座。如果不确定是否已可靠接地，请让一位合格的电工或维修人员检查确认。请确保产品使用的电源插座接线符合国家标准(左零右火)，不能接反。

警告



- 本产品必须连接到220V/50Hz、负载电流至少为10A的专用标准插座及配线，且插座必须配备接地故障断路器或接地漏电保护器或类似的高敏感、快速型漏电开关（额定敏感电流10mA以下）。
- 插座位置需安装在不易被水淋到的地方，建议使用防水型插座。
- 安装应使用随器具附带的新软管组件及其它附带或指定的零部件，旧软管组件不能重复利用，否则可能引起漏水、火灾或触电。
- 当产品由寒冷或潮湿的地方搬至室内时，先放置2小时，使机内凝水充分挥发，再开机使用，以免造成产品短路。

注意



- 打雷时，拔出电源插头。
- 请勿将产品放置在可能掉入或被拉入浴缸或水槽的位置。
- 请勿将产品放置在水或其他液体中。
- 请勿触及已经掉入水中或浸水的产品，并立刻拔掉电源插头。
- 请勿站在坐便器上，不要用重力撞击陶瓷，以防止破损漏水。
- 禁止坐便器底座埋入胶凝材料（水泥砂浆），否则可能因膨胀而撑裂陶瓷。
- 禁止施加强力或冲击，不要站在座圈、便盖或本体上，不要放置重物。
- 禁止使用香蕉水、汽油、药水及洗涤剂、杀虫剂、厕所清洁剂和硬毛刷清洁本产品。
- 请勿使用GB 5749标准自来水以外的水源，否则可能会引起系统故障或皮肤发炎等问题。
- 请勿让阳光直接照射产品，以免产品变色及影响遥控接收效果。
- 本产品座圈和便盖有缓降功能，请勿用力按压，以免损坏缓降器。
- 请勿将进水管与热水器出水管连接，进水温度3-35°C，超过规定范围将可能导致内置加热组件不工作。
- 使用产品时，请勿向后靠在便盖上，以免损坏产品。
- 请不要向坐便器内冲入新闻纸、纸尿裤、妇用卫生巾等容易堵塞的物品。
- 产品功能不正常或发生故障时，请立即停止使用并切断电源，并及时与服务商联系。



- 进行安装、拆卸、维修及保养产品时，必须拔下电源插头，关闭供水阀门。
- 不要在0°C以下环境中使用，如果室温低于0°C，必须将水箱内水排空，防止水箱冻裂。
- 如果长期不使用，必须切断电源，并将水箱内的水排空。
- 身体、感知、智力能力缺陷或经验和常识缺乏的人（包括儿童）使用时，需要在专人的监护下使用本产品，心脏病患者请谨慎使用。
- 请勿让儿童玩耍本产品。
- 预防因冻结而造成的损坏，请实施保暖措施，提高厕所温度。
- 使用前请放水清洗进水管，避免进水管阻塞。

所需工具及材料(不随货供应)

- 活络扳手×2
- 卷尺
- 生料带
- 美工刀
- 冲击钻
- 各种螺丝刀
- 玻璃胶枪
- 玻璃胶
- 记号笔
- 水平仪

尺寸图

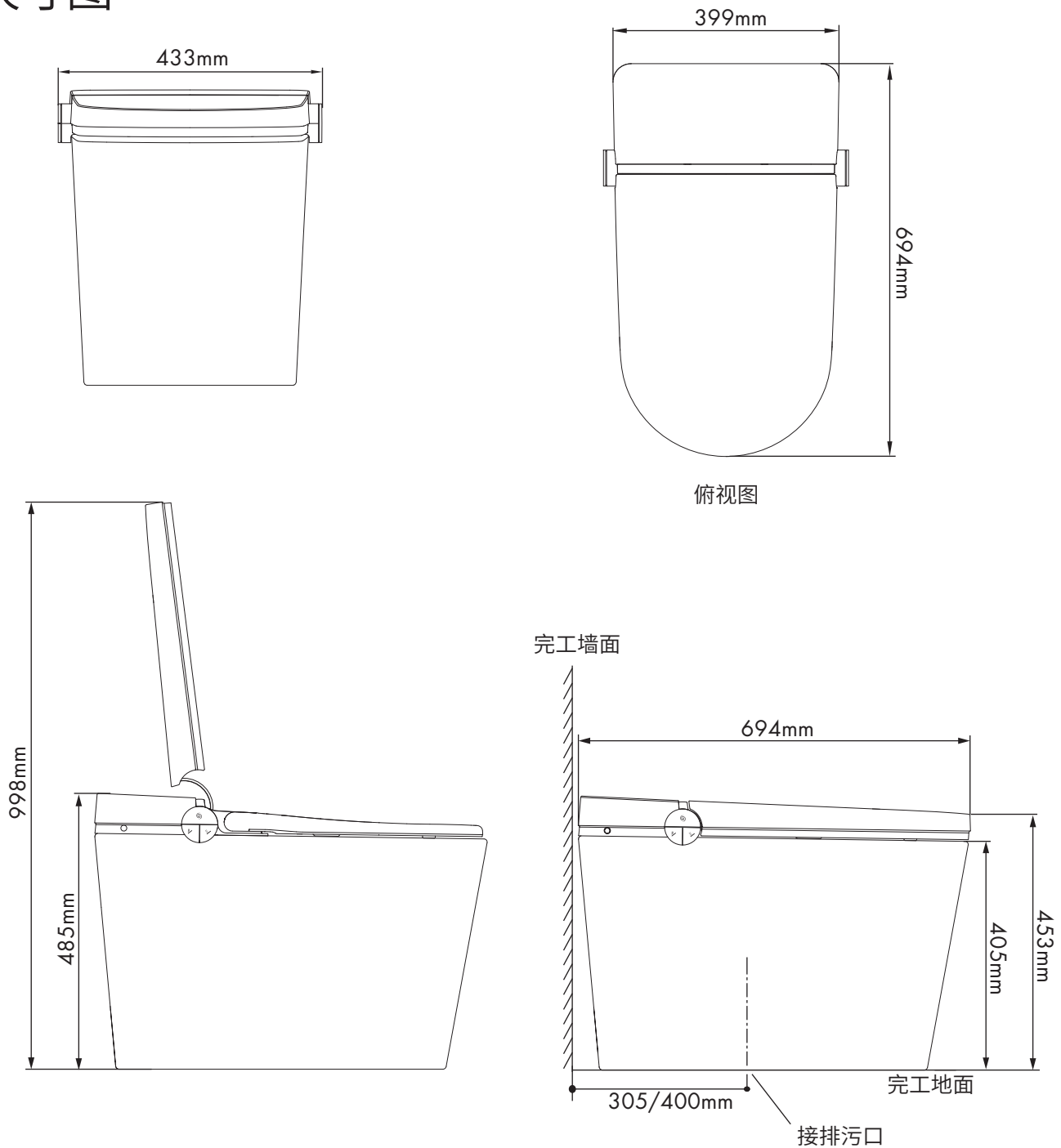

备注: 1.本说明书产品外形图仅供参考,我们保留对产品外形修改的权利。
2.产品外观如有改动,以实物为准。

技术规格

项目		22452007	22453007	22454007	22455007	22456007
区分		豪华版		舒适翻盖版	舒适版	
坑距		305mm坑距	400mm坑距	305mm坑距	305mm坑距	400mm坑距
额定电源		交流220V 50Hz				
*额定功率		1065W		1015W		
进水软管长度		约870mm				
电源线长度		约1.5m				
防水保护等级		IPX4				
坐便器	平均用水量	4.8L(全排6.0L/半排4.2L)				
	进水方式	直接连接自来水				
	冲洗方式	喷射虹吸式				
	排污口外径	≤100mm				
	排水方式	下排水				
功能部	洗净装置	加热方式	即热式			
		温水温度	温度调节范围：关/约32-39°C			
		加热功率	1600W			
		清洗流量	3档调节			
		清洗方式	臀洗、妇洗、移动清洗、按摩清洗	臀洗、妇洗、移动清洗		
		喷洗位置	3档调节			
		水压保护	稳压装置、自动泄压装置			
		防污装置	喷嘴自动清洗装置、防虹吸装置、防倒流装置、过滤装置			
		安全装置	温度保险丝、水温传感器、接地保护、温控器、漏电保护			
	暖风装置	暖风温度	温度调节范围：约43-53°C			
		风量	≥0.2m³/min			
		加热器功率	210W			
		安全装置	温控器、温度保险丝、漏电保护			
	加热座圈	表面温度	温度调节范围：关/约31-39°C			
		加热器功率	50W			
		防低温烫伤	使用10分钟后，座温自动缓慢降低到低档（约31°C）			
		安全装置	着座感应器、温度传感器、温度保险丝、温控器、漏电保护			
	翻盖功能	自动感应翻盖	●	●	●	X
		遥控开关便盖和座圈	●	●	仅开盖	X
	贴心设置	除臭方式	水净味	●	X	X
净离子除菌		●	●	X	X	
夜灯设置		智能				
自动冲水功能		离座后自动冲水				
断电冲水功能		手动冲水				
进水压力	0.08MPa(动压) - 0.8MPa(静压)					
进水温度	3°C-35°C					
环境温度	1°C-40°C					
**抑菌部位	座圈、喷嘴、陶瓷釉面					
**UV灯除菌部位	喷嘴					
**净离子除菌部位	喷嘴、陶瓷内壁	●			X	
产品尺寸	长694mm×宽433mm×高485mm					
产品重量	46kg					
产品执行标准	GB 4706.1-2005 / GB 4706.53-2008					

说明：

*额定功率：本产品依GB 4706.1-2005 / GB 4706.53-2008标准，在环境温度23°C，进水静压0.18MPa±0.02MPa，进水温度15°C条件下，开始上电开机，依次将水压、座温、水温设置为最高档后，立即开启臀洗并持续稳定工作一个清洗周期的平均功率。(豪华版：测试过程中需开启移动清洗和按摩清洗功能；舒适版翻盖版及舒适版：测试过程中需开启移动清洗功能。)

**本产品符合ISO 22196-2011标准中的除菌性能要求。本产品可实现大肠杆菌/金黄色葡萄球菌的去除。

本产品符合GB/T 23131-2019标准中的清洁率要求。本产品最佳清洁率测试方法：将喷杆位置调至最前端，水压档位调至最大档，同时开启移动清洗功能。

整体简图

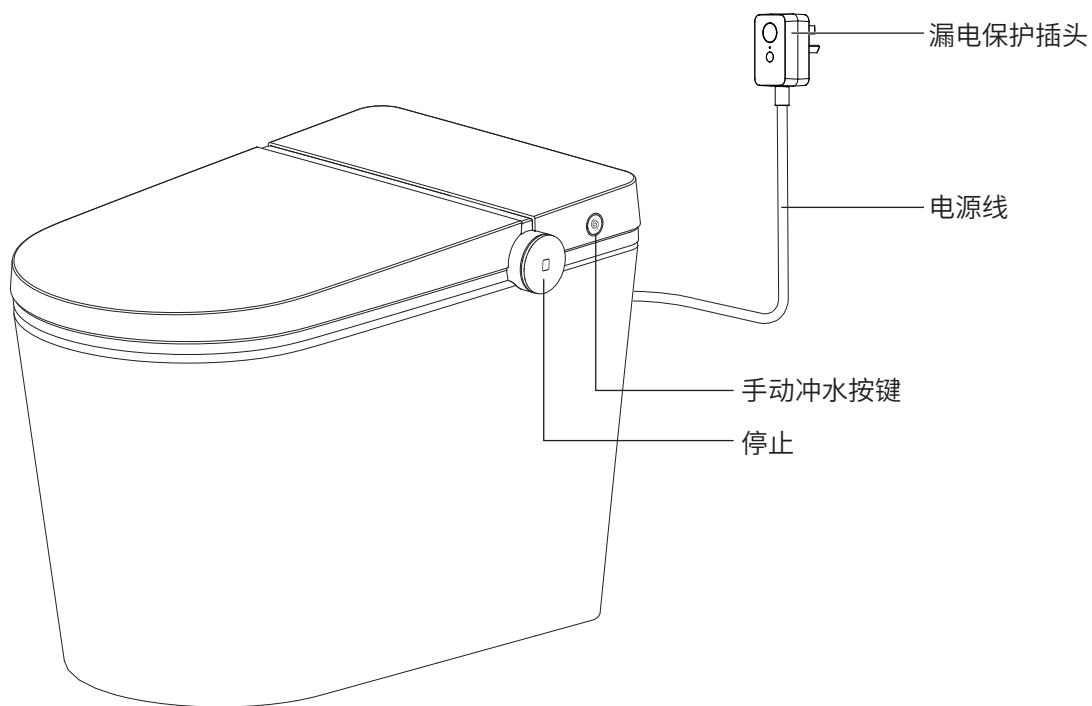
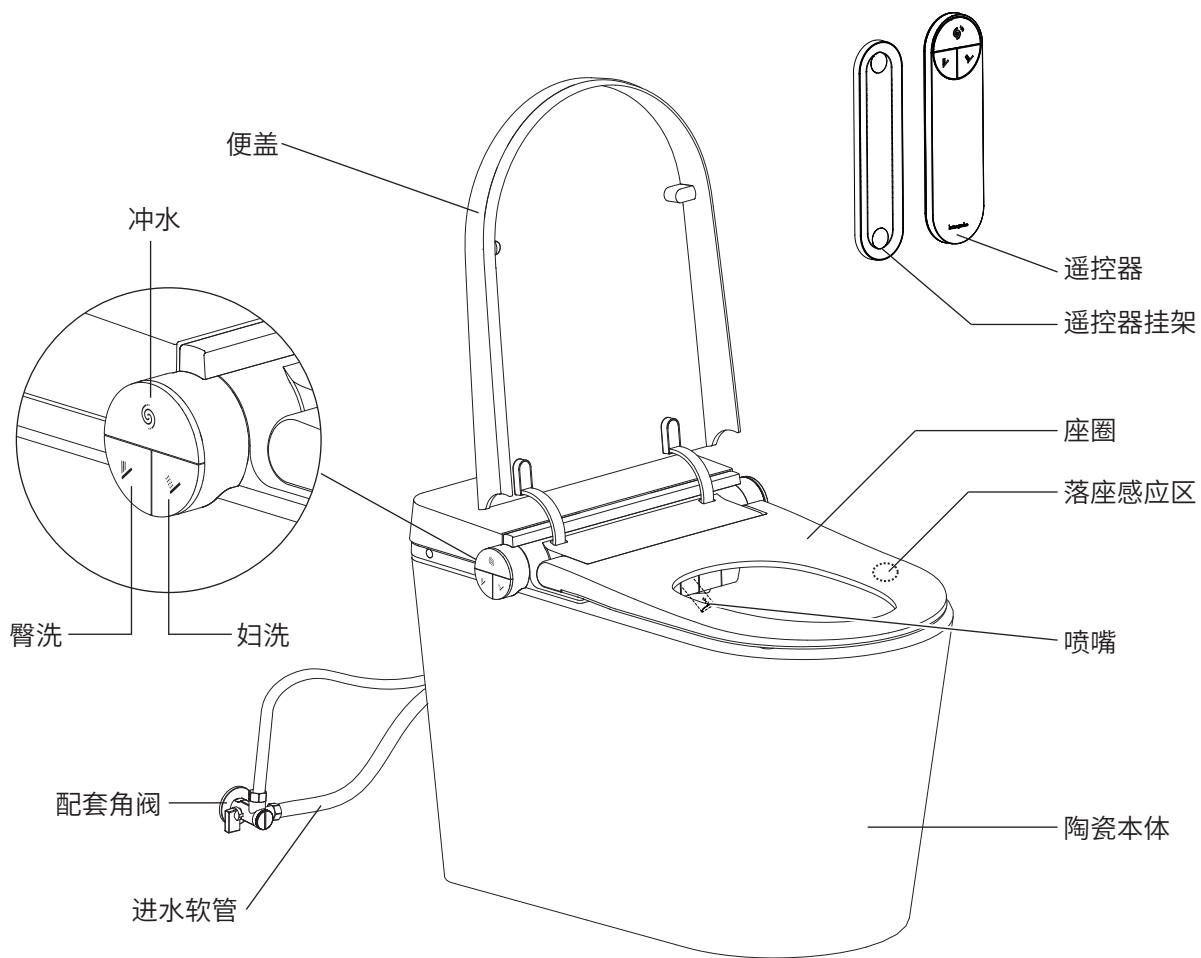

产品清单

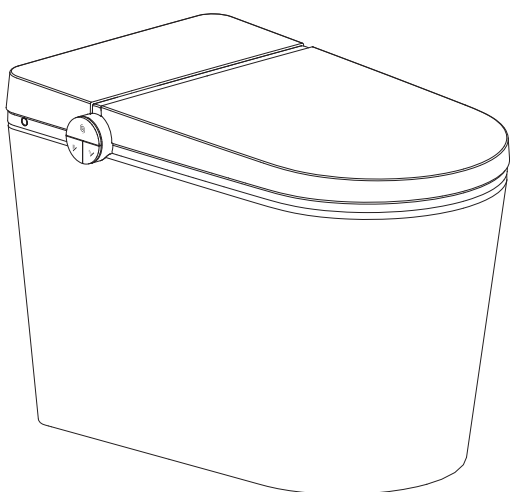

智能一体坐便器

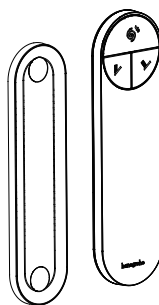

遥控器和遥控器挂架

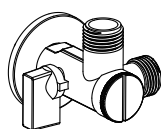

配套角阀



密封法兰

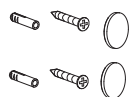

遥控器挂架膨胀螺钉组
与硅胶垫



对孔纸板



纽扣电池(型号CR2450)



合格证



说明书



保修卡 (附于说明书内)

安装坐便器

1. 安装配套角阀

- 提示：1.若墙面已安装旧角阀，需由专业人员进行更换，避免因拆卸不当导致角阀无法安装。
2.必须使用配套角阀，否则可能造成管路堵塞。

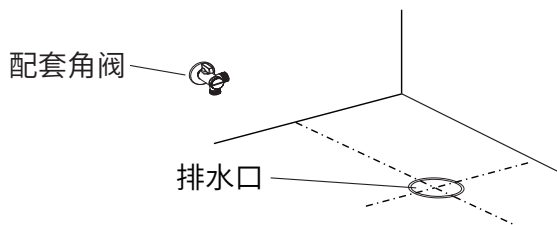

2. 对孔纸板安装说明

- 用地平仪测量地面，确保安装面积地面平整；
将对孔纸板对齐排污口中心线，根据对孔纸板描绘出相应的轮廓线后移除纸板。

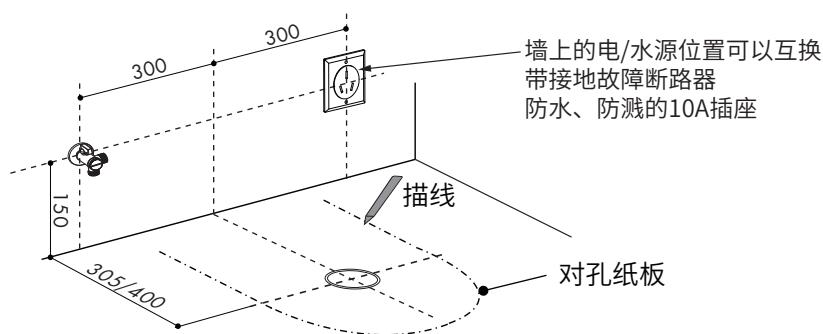

3. 安装坐便器

- 将密封法兰套入坐便器排污口；
根据描绘出的轮廓线将坐便器装入相应位置。

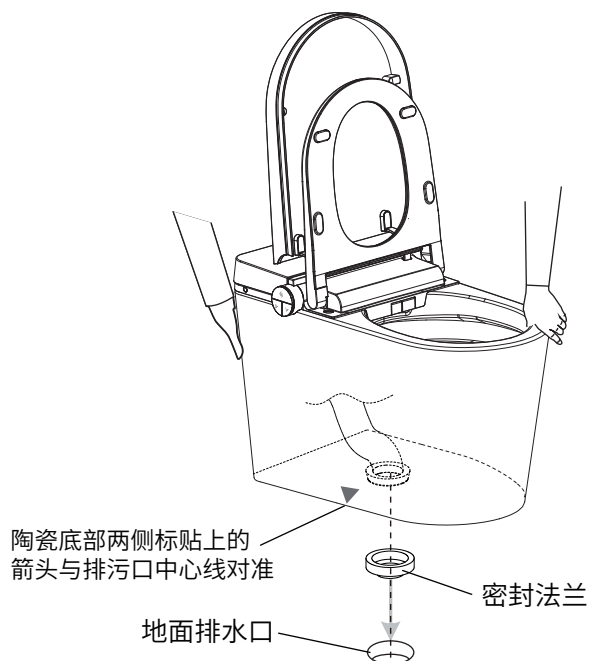

- 温馨提示：由于一体机比较重，需翻开座圈，由两人配合抬起；
严禁从盖板部分搬运产品（容易引起机械故障）。

4. 安装进水软管

用配套进水软管将坐便器的进水口和角阀连接起来，并旋紧。

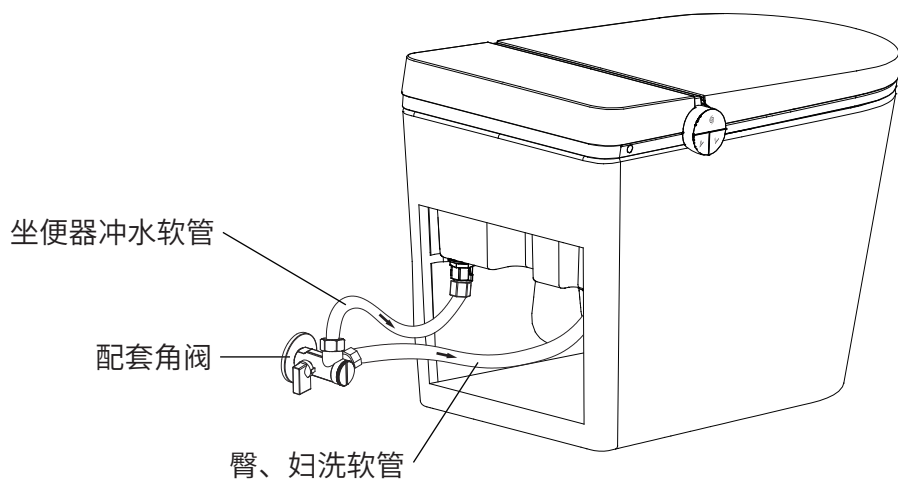

5. 涂玻璃胶

在便器下边缘周围涂上优质防霉玻璃胶。

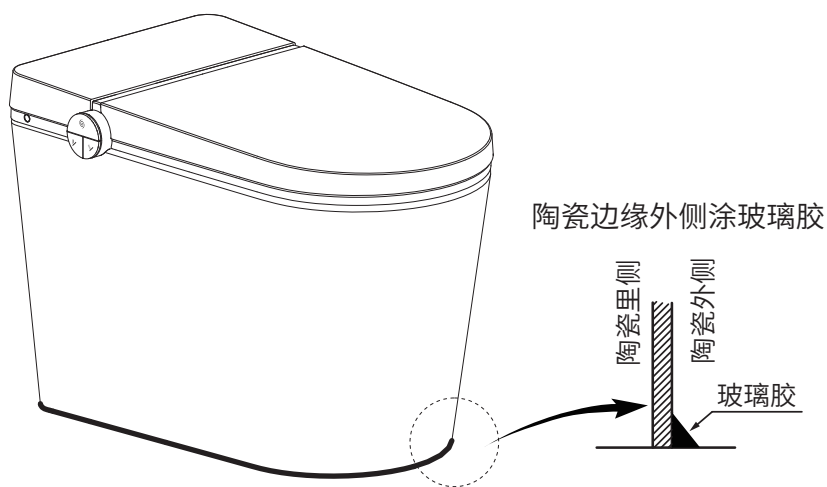

温馨提示：请将排污口的垃圾和其他污物清理干净；
安装坐便器时，请确保坐便器排污口与地面排水口安装到位。

安装遥控器

请勿在潮湿的环境下安装使用产品，禁止置于易被水淋到的地方。

1. 安装遥控器挂架

- ① 将遥控器挂架竖直贴紧在墙上的预安装区域，用记号笔在墙上标识出两个安装孔的位置。
- ② 用 $\phi 6\text{mm}$ 的钻头在墙上已标识的位置钻孔，深度35mm。
(确定安装位置时，需注意当人坐在座圈上，手可以很容易的拿到遥控器)
- ③ 将膨胀管装入墙孔内，挂架贴紧墙壁，挂架上孔对准膨胀管，放入螺钉锁紧，再盖上硅胶垫。

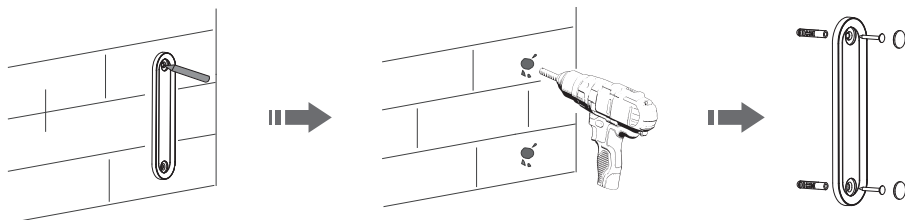

2. 安装遥控器电池

- ① 往上推电池盖，打开电池盖。
- ② 逆时针方向旋开电池密封盖，将新电池(+级朝上)装入遥控器内，再顺时针旋上电池密封盖。

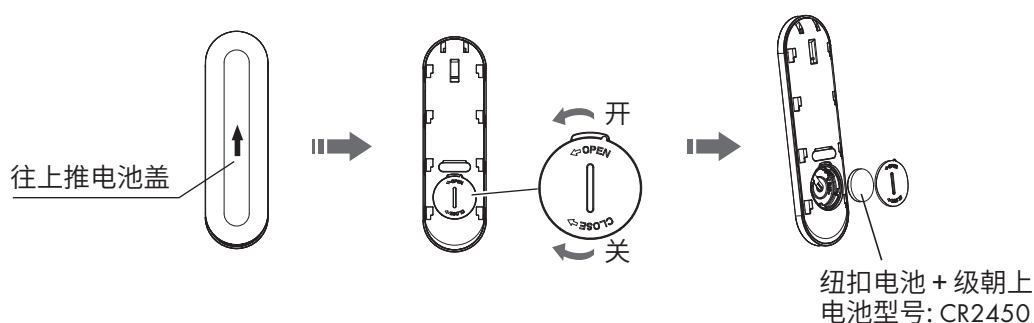

- ③ 盖上电池盖。
- ④ 将遥控器放入挂架中（挂架有磁式吸附功能）。

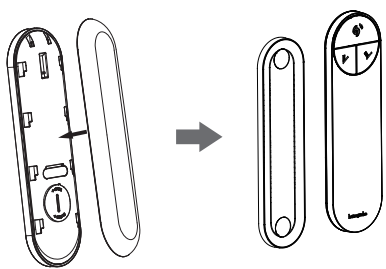

⚠ 电池使用注意事项

- ① 请使用指定的电池型号，不得随意更换电池型号，否则将导致产品损坏，严重可导致过热、燃烧等安全隐患。
- ② 安装时请认清正、负极标记，防止短路和正、负极错接。
- ③ 妥善保管好纽扣电池，防止被婴幼儿小孩等吞入口中。
- ④ 废弃纽扣电池请按照国家环保法处理，切勿随意丢弃。
- ⑤ 按照4人家庭(男性：2人、女性：2人)，使用频度：大便1次/天·人，小便4次/天·人，纽扣电池使用周期约为6个月；当遥控器电池状态指示灯红色闪烁显示时，提示电池电量低，请及时更换电池。

使用前准备

1. 打开角阀

查看螺纹连接处密封性，确定不漏水，逆时针旋开角阀，开口调至最大。
(温馨提示：初次开启时，角阀把手扭力较大)

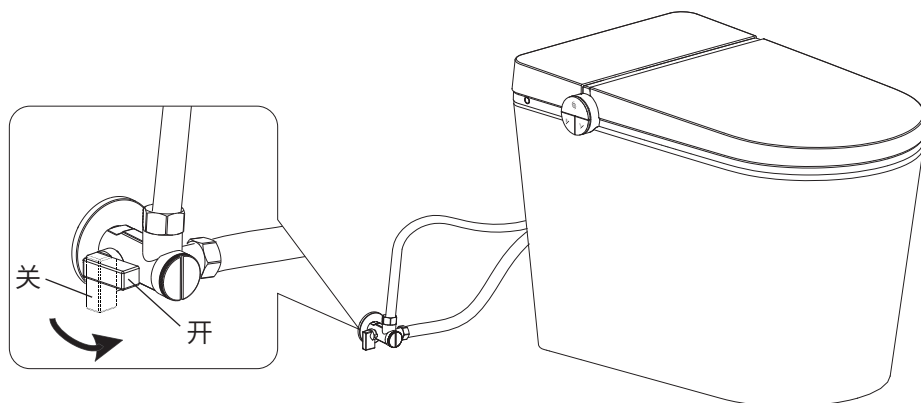

2. 接通电源

电源线漏电保护插头插入电源插座，按下复位键，电源指示灯亮，表示通电。

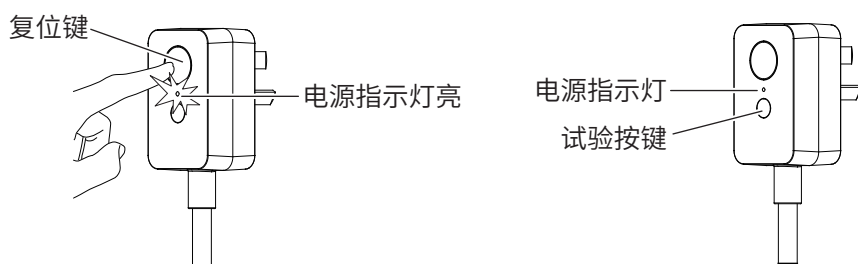

温馨提示：使用前先按下漏电试验按键，复位键弹起，指示灯熄灭，表示漏电保护功能正常。

3. 安全自检

- ① 上电后，主机蜂鸣器一声“嘀”，夜灯闪烁，侧按键指示灯蓝、白灯交替闪烁，开始自检；
- ② 主机蜂鸣器响再一声“嘀”，自检完毕，停止闪烁；
- ③ 功能模式开启，正常使用。

自动开关盖功能 (*仅限豪华版22452007、22453007/舒适翻盖版22454007)

如果您购买的是带自动开关盖功能的电子坐便器，本产品能实现自动开/关便盖功能。
(自动开关盖功能默认出厂设置为关闭,首次使用需长按遥控器开关盖“”键大于3秒开启,操作方法详见第17页。)

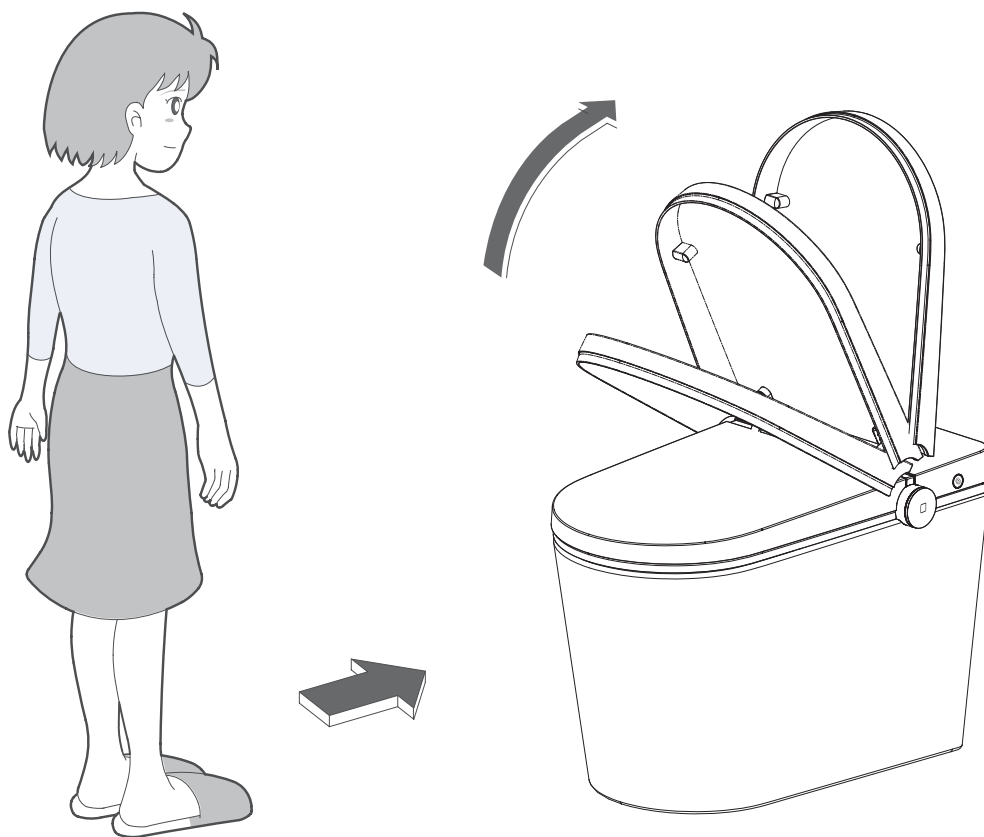

1.靠近坐便器时

当人体靠近坐便器,主机检测到人体的活动后,便盖自动打开。

2.使用坐便器时

当人体离开坐便器约90秒后,便盖自动关闭。

3.男士站立小便时

利用遥控器(仅限豪华版)或手动打开座圈,使用完离开坐便器后,便盖约在90秒后自动关闭。

本体按键功能

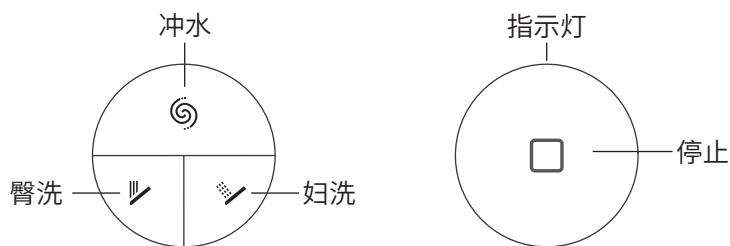

侧按键操作说明：

- 1、落座时，短按“妇洗/臀洗”键，开启妇洗/臀洗功能，短按“停止”键，关闭功能。
- 2、离座时，短按“妇洗/臀洗”键，执行手动清洁喷嘴功能，短按“停止”键，关闭功能。
- 3、短按“冲水”键，执行大冲水功能。
- 4、同时按“臀洗”和“妇洗”键3秒以上，开启/关闭自动节能功能。开启时，连续离座48小时以上，座圈加热关闭；落座时，恢复上次所使用的温度档位。
- 5、离座时，长按“停止”键，进入待机模式，本机上白灯慢呼吸状态。
- 6、待机模式下，长按“停止”键，退出待机模式，本机上白灯常亮。
- 7、正常工作模式下，开启臀洗、妇洗、暖风、清洁喷嘴等功能时，本机上白灯呼吸状态；开启净离子除菌功能时，本机上蓝灯呼吸状态。
- 8、短按“停止”键，将停止臀洗、妇洗、暖风、清洁喷嘴、净离子除菌功能。

遥控器使用方法

豪华版



遥控器使用方法(续)

舒适翻盖版





舒适版





冲水功能



1. 短按“”键，启动全冲功能，马桶开始大冲水。
2. 双按“”键，启动半冲功能，马桶开始小冲水。
3. 长按“”键，自动冲水指示灯闪烁，按住3秒以上，设置开启或关闭自动冲水功能；自动冲水功能设置开启时，自动冲水指示灯亮起，5秒内无操作指示灯熄灭。功能开启时，离座后会自动进行大/小冲水功能。



臀洗功能



落座状态下，短按“”键，开启臀洗功能，喷杆伸出，喷水清洗臀部。清洗过程中，再次短按“”键或短按“”键，可立即停止臀洗功能。

妇洗功能



落座状态下，短按“”键，开启妇洗功能，喷杆伸出，开始喷水清洗。清洗过程中，再次短按“”键或短按“”键，可立即停止妇洗功能。

移动清洗功能



在“臀洗”或“妇洗”时，短按“”键，开启移动清洗功能，喷嘴前后移动，扩大洗净范围。



按摩清洗功能 (*仅限豪华版)



在“臀洗”或“妇洗”时，短按“”键，开启按摩清洗功能。



暖风功能



落座状态下，短按“”键，暖风功能启动，开始出风。暖风过程中，再次短按“”键或短按“”键，可立即停止暖风。

翻盖功能 (*仅限豪华版及舒适翻盖版)



- ① 短按“”键，打开或关闭便盖。
- ② 长按“”键，自动开关盖指示灯闪烁，按住3秒以上，设置开启或关闭自动开关盖功能；自动开关盖功能设置开启时，自动开关盖指示亮起，5秒内无操作指示灯熄灭。
(自动开关盖功能默认出厂设置为关闭，首次使用需打开)

翻圈功能 (*仅限豪华版)



短按“”键，打开或落下座圈。

水压调节





在“臀洗”或“妇洗”时，短按水压调节“+”，“-”键，指示灯亮起，显示水压档位，调节3档水压大小。

指示灯显示与档位对应如下图：



喷嘴位置调节



在“臀洗”或“妇洗”时，短按喷嘴位置“”，“”键，指示灯亮起，显示喷嘴档位，可在3档之间调节喷嘴位置前移、后移。

指示灯显示与档位对应如下图：



水温调节



在“臀洗”或“妇洗”时，短按“”键调节水温，指示灯亮起显示水温档位，指示灯不亮时为0档(常温档)，档位调节方式为0-3档依次循环。

指示灯显示与档位对应如下图：



风温调节



暖风状态下，短按“”键调节风温，指示灯亮起显示风温档位，指示灯不亮时为0档(常温档)，档位调节方式为0-3档依次循环。

指示灯显示与档位对应如下图：



座温调节





短按“”键调节座温，指示灯亮起显示座温档位，指示灯不亮时为0档(常温档)，档位调节方式为0-3档依次循环。

指示灯显示与档位对应如下图：





净离子除菌 (*仅限豪华版)



- ① 无人落座时，短按“”键，开启喷嘴和陶瓷内壁净离子除菌功能。
- ② 长按“”键大于3秒，开启或关闭自动净离子除菌功能，开启时蜂鸣器“嘀”响1声，关闭时“嘀”响3声。功能开启时，连续24小时未使用净离子除菌功能，则自动开启一次喷嘴和陶瓷内壁净离子除菌功能。



夜灯设置



短按“”键，打开智能夜灯（依外界环境明/暗自动关/开夜灯），蜂鸣器“嘀”响1声；再次短按“”键，关闭智能夜灯，蜂鸣器“嘀”响3声。

清洁喷嘴



无人落座时，短按“”键，喷杆伸出，开启手动清洁喷嘴，10分钟后或短按“”键，喷杆自动缩回。

※ 落座清洗状态下，操作无效。





电池状态



电池状态指示灯若红色闪烁显示，提示电池电量低，请及时更换遥控器电池。（操作方法详见第11页）

遥控器对码

通电开机状态下：

- ① 先按住“”键，再按下“”键，指示灯闪烁；
- ② 10秒内，再次先按住“”键，再按下“”键；
- ③ 指示灯停止闪烁并长亮2秒，对码成功。

若第一次使用时，按遥控器无反应或更换新遥控器时需重新对码后才能正常使用。若对码失败，请按上述步骤重新对码。（对码需在通电开机自检完成后30秒内）

温馨提示：

1. 人体必须落座，蜂鸣器“嘀”响一声，臀洗、妇洗、暖风功能才可以使用。
2. 坐在座圈上时请尽量靠后，洗净位置就容易对准，也不会出现溅水的现象。
3. 在喷洗过程中，人若站起，喷嘴还会维持喷水1-2秒，请先按“停止”键后再站起。
4. 每次按按键，蜂鸣器“嘀”响一声，表示主机接收到信号，并执行信号。如果蜂鸣器“嘀、嘀”响两声，表示无效音。

本体的保养

- 1.切断电源：本体保养时请先切断电源。
- 2.柔软抹布擦拭：请用拧干水分的柔软抹布擦拭脏污部位。
- 3.安全自检：擦拭完成后请重新接上电源。
- 4.使用过程中若发现坐便器有移动或晃动，请检查硅胶是否老化松动，如果松动需要铲除重新涂抹。

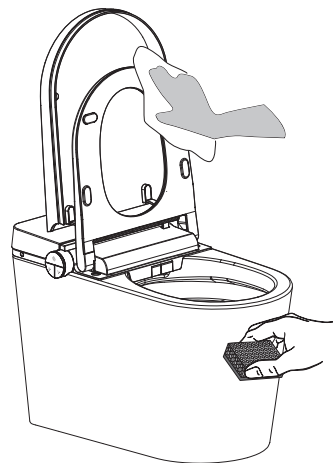

遥控器的保养

请用拧干水分的柔软抹布擦拭脏污部位。

⊘ 严禁直接用水或清洁剂冲洗本产品。

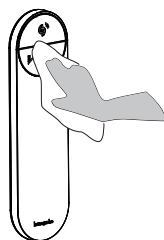

喷嘴的保养

- 1.喷嘴伸出：人体无着座，短按遥控器“清洁喷嘴”键，启动喷嘴手动清洗功能，喷嘴会自动伸出。
- 2.喷嘴擦拭：喷嘴自动伸出以后，请用柔软抹布或软毛刷擦拭（中性清洁）。请勿将喷杆外拉或内推，以免破坏喷杆或电机。
- 3.收回喷嘴：10分钟后或短按“停止”键，喷杆自动缩回。

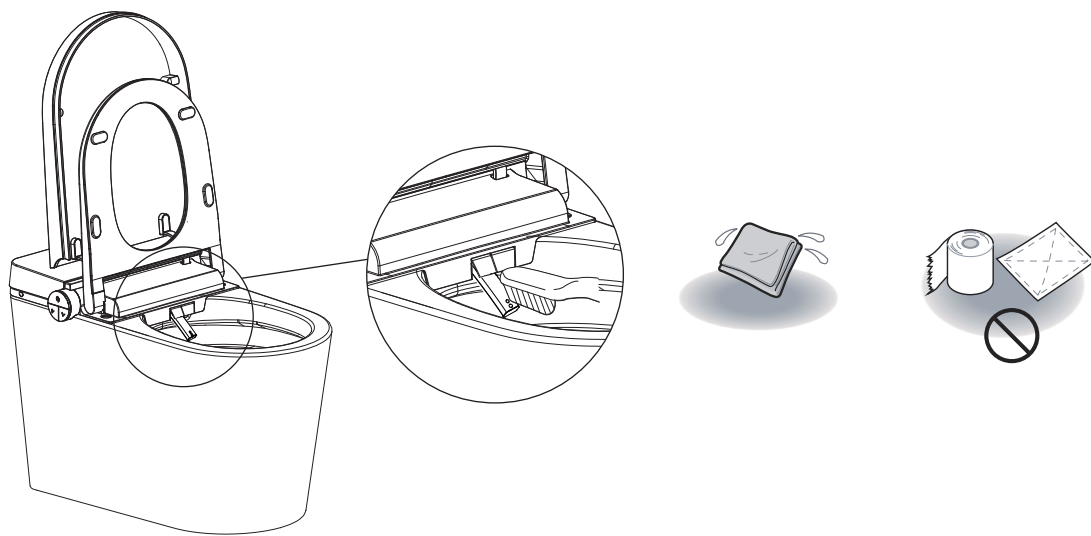

清洗过滤网

保养时机：当水压正常但冲刷效果不佳时。

1.关闭角阀，旋开角阀螺母，取出过滤网

2.装回过滤网，重新安装角阀螺母，打开角阀

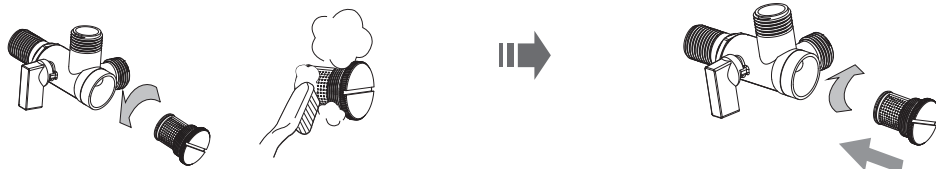

停电停水时

1. 停电时冲洗坐便器的方法:

按下手动冲水按键(长按4秒以上)，进行冲洗。

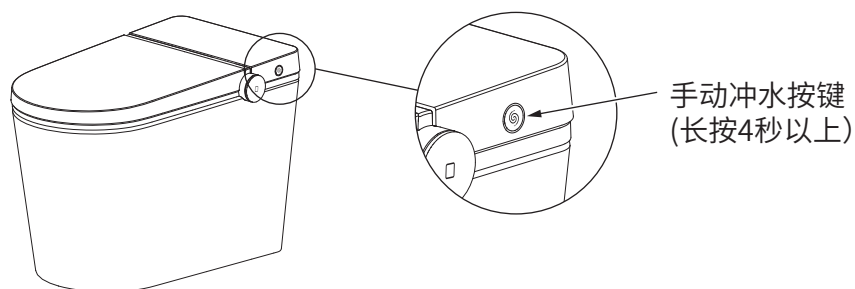

2. 停水时冲洗坐便器的方法:

将水放入较大的水桶(约8L)内，以坐便器槽面为中心进行冲洗。此时，注意防止水从坐便器溢出。

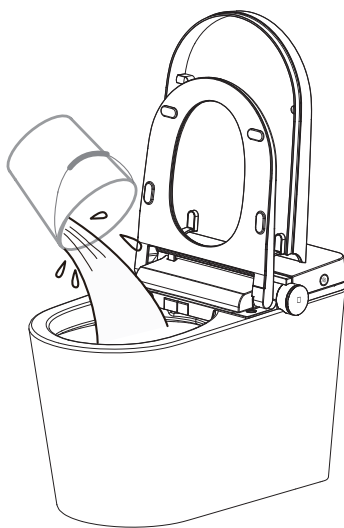

长时间不使用时

尤其是冬季，长期不在家时，请务必将水箱及管路中的水放空，防止冻结。

放水的方法:

1. 拔出电源插头，切断电源。
2. 将马桶水箱中的水排空：关闭进水角阀，长按手动冲刷按键将水排空。
3. 将管路中的水排空：将软管从角阀上旋开，排空管路的水后重新装回。



4. 处理坐便器内积水:

为了安全起见，建议将防冻液放入便器内的积水中。

温馨提示：在放水前，必须切断电源！再次使用坐便器时，请务必再次通水、通电。

常见故障诊断和排除

现象	原因	处理
不喷水	进水管弯折造成堵塞	排除进水软管弯折
	角阀关闭	打开角阀
	自来水断水	等待来水
喷水强度弱	进水管弯折造成部分堵塞	排除进水软管弯折
	角阀未完全打开	完全打开角阀
	进水滤网阻塞	清洗进水滤网
水温不热	水温设定常温档	重新设定水温档位
座温不热	座温设定常温档	重新设定座温档位
	处于待机或节电模式	切换到功能模式3分钟后使用
风温不热	风温设定常温档	重新设定风温档位
不出风	处于待机模式	切换到功能模式使用暖风功能
喷杆不缩回	断电	等待来电, 或轻轻将喷杆推回
	被异物卡住	清除异物
喷杆不伸出	断电	等待来电
	未坐到着座感应区	位置坐正, 坐到感应区
遥控器失效	遥控器电池正负极装反	重新装电池, 对准正负极
	遥控器电池电量不足	更换新电池
除臭功能不正常工作(*豪华版)	使用者没有接触座圈上的感应器	调整至接触到座圈上的感应器
	离开座圈后, 除臭功能继续工作	离开座圈后, 除臭功能会继续工作一段时间消除异味, 这是正常现象
 注意	如果按上述方法处理后故障仍未排除, 应切断电源, 联系服务商, 请专业人员维修	
	如果电源漏电保护开关时常跳开, 表示产品有漏电, 请切断电源, 联系服务商, 请专业人员维修	

电子电气有害物质限制指示表

部件名称	有害物质					
	铅(Pb)	汞(Hg)	镉(Cd)	六价铬(Cr(VI))	多溴联苯(PBB)	多溴二苯醚(PBDE)
电源线	×	○	○	○	○	○
电路板	×	○	○	○	○	○
着座传感器	×	○	○	○	○	○
温度传感器	×	○	○	○	○	○
温度保护器	○	○	×	○	○	○
接地片	×	○	○	○	○	○
进水软管	×	○	○	○	○	○
膨胀螺栓	×	○	○	○	○	○
角阀	×	○	○	○	○	○
稳压组件	×	○	○	○	○	○
电机组件	×	○	○	○	○	○

○:表示该有害物质在该部件所有均质材料中的含量均在GB/T 26572规定的限量要求以下。
 ×:表示该有害物质至少在该部件的某一均质材料中的含量超出GB/T 26572规定的限量要求。

环境保护使用期限



此标志中的年数,是基于SJ/T 11364-2014【电子电气产品有害物质限制使用标识要求】的环境保护使用期限。

只要遵守使用说明书上记载的此产品安全与使用方面的注意事项,从制造日算起的此年限内,就不会发生由于使用产品引起有害物质的外泄或突变,不会对环境造成严重污染或对使用者人身及财产成严重损害。

【环境保护使用期限】不是安全使用期限亦不是品质保证期限,产品不适合继续使用需要废弃时,请遵守电子电气产品回收再利用相关的法律规定进行处理,感谢您的配合。

备注:根据产品的型号不同,您所购买的产品可能不会含有以上的所有部件。

能效水效等级说明

本公司智能坐便器产品能效水效等级符合GB 38448《智能坐便器能效水效限定值及等级》的要求,智能坐便器能效水效等级指标如下表:

智能坐便器能效水效等级		1级	2级	3级
能效等级指标	单位周期能耗/(kW·h)			
	带坐圈加热功能	≤0.030	≤0.040	≤0.060
	不带坐圈加热功能	≤0.010	≤0.020	≤0.030
水效等级指标	智能坐便器清洗平均用水量/L	≤0.30	≤0.50	≤0.70
	*智能坐便器冲洗平均用水量/L	≤4.0	≤5.0	≤6.4
	*双冲智能坐便器冲洗全冲用水量/L	≤5.0	≤6.0	≤8.0

注1:“*”适用于一体式智能坐便器。

注2:每个水效等级中双冲智能坐便器的半冲平均用水量不大于其全冲用水量最大限定值的70%。

(注:您所购买的产品的能效水效等级以产品或包装物上标识的能效水效等级为准。)

产品保修卡

产品型号		客户姓名	
销售单位		购买日期	
发票号码		客户电话	
经销商盖章		经销商电话	

感谢您购买本公司产品!为确保产品信誉及维护您的消费权益,自购买日起(以购买单据日期为准),本公司将为您提供免费的保修服务:电子部分一年,陶瓷部分五年,官方服务平台注册成功后,电子部分延保一年,如产品用于商业用途整机保修一年,敬请放心使用。

按照说明书和使用注意事项正常使用后发生故障时,在保修期内免费维修。保修期内因故障要求维修时,可凭保修卡和原始发票与本公司联系,进行免费维修或更换(如果没有同样的型号则以类似型号代替,本公司保留此权利)。

如果超过保修期或遗失保修卡,本公司也提供维修服务并收取成本费用。

该有限责任仅适用于中国大陆(不包括香港、澳门、台湾)。

本公司产品的有限责任承担适合购买的本公司产品,保修期内以下情况下进行收费维修:

- 1.因使用不当,误操作或者不正当的修理改造而造成的损坏。
- 2.移动安装位置所造成的损坏。
- 3.由火灾、地震、水灾、雷击、冰冻及其他自然灾害,公害和气体灾害、硫酸、盐酸、异常电压引起的损坏。
- 4.因使用非指定电源(电压、频率)发生的损坏。
- 5.用于一般家庭或者酒店以外的用途,所发生的损坏。
- 6.因淤积的沙土、污物而产生的使用不良及包装等易耗品造成的损坏。



全国统一服务热线: 400-820-3555

为保障您的服务权益,请在安装后及时扫码注册

Contents

Installation

Safety Instructions	25
Tools and materials required	27
Dimensions	27
Technical Specifications	28
Sketch	29
List of Materials	30
Installation of the ceramic toilet	31
Installation of the remote control	33

Instructions for Use

Preparation before Use	34
Automatic lid opening/closing function	35
Functional Buttons of Main Unit	36
Usage of Remote Control	36

Routine Maintenance

Maintenance and Care of Main Unit	41
Maintenance and Care of Remote Control	41
Maintenance and Care of Spray Nozzle	41
Filter cleaning	41
When the electricity and water supply is cut-off	42
When this product is left unused for a long time	42

Other

Fault Analysis and Solution	43
Information on the Use of Hazardous Substances in Electrical and Electronic Devices	44
Grade of the energy efficiency and water efficiency	44
Warranty Card	45

Safety Instructions



Please read this manual carefully before installation, and install this product in strict accordance with the manual. After reading, please keep this manual properly in a safe place.



To prevent users and others from injuries and property damages, please strictly observe the safety warnings and precautions.

Symbol Illustration

Warning	It indicates that serious injuries or deaths may be caused if you do not follow the instructions in this warning and operate this unit incorrectly.
Caution	It indicates that injuries or property losses may be caused if you do not follow the instructions in this caution and operate this unit incorrectly.

The following symbols are used to indicate important safety precautions when this product is used.

Symbol	Description
	This symbol indicates something to not do, meaning [prohibited].
	This symbol indicates something that must be performed [must do].

Warning	
	<ul style="list-style-type: none"> Do not put lit cigarettes and other burning materials into the toilet seat. Otherwise, it may cause a fire. Never disassemble, repair or modify this product by yourself. Otherwise, it may cause a fire or an electric shock. Never pour water or detergent on the main unit or the power plug. Otherwise, it may cause a fire or an electric shock. Never touch the power plug with wet hands. Otherwise, it may cause electric shock. Never use other electrical appliances on the same socket with this product. Never use an extension power cord or a loose and unstable power socket. Otherwise, it may cause a fire or an electric shock. If the flexible power cord is damaged, it must be replaced by a professional in order to avoid danger. This product is an electrical product. Never place it in a place where it is likely to be damped by water. Never put fingers or other objects into or block the warm wind outlet. Otherwise, it may cause scalds, electric shocks or burns. When this product is energized, do not lay this product on its side or invert it. Otherwise, it may cause a fire or burns. Do not install or use this product in a bathroom or other damp places.
	<ul style="list-style-type: none"> This product must be grounded securely. Make sure to provide grounding protection for the AC socket, and use the three-pin socket for the grounding wire. If you are not sure if it is grounded securely, ask a qualified electrician or service person to check and verify the condition. Please make sure the wiring of the power socket used for this product is in compliance with the national standard (null line on the left and live line on the right) and should not be reversed.

Warning



- This product must be connected to a 220V/50Hz special standard socket and wiring with the minimum load current of 10A. The socket must be equipped with a ground fault circuit breaker or a ground leakage protector or other similar fast leakage protection switch with high sensitivity (with the rated sensitive current of 10mA or less).
- The socket should be located so that it is unlikely to be damped by water. A waterproof socket is recommended.
- During installation, the new hose set and other attached or specified components that are supplied with the unit should be used, and the old hose set should not be reused. Otherwise, it may cause water leakage, fire or electric shock.
- To prevent this product from short circuit, when moved to a room from a cold or moist place, it should be left in the room for 2 hours at first to allow the condensate inside the unit to evaporate fully, and then turned on.

Caution



- Please disconnect the power plug when it thunders.
- Do not place this product at a place where it may fall or be pulled into a bathtub or sink.
- Do not place this product in water or other liquids.
- Do not touch this product when it has fallen into or immersed in water. Disconnect the power plug immediately.
- Do not stand on the toilet or strike the ceramic with heavy force, so as to prevent the toilet from damage and water leakage.
- Never embed a cementitious material (cement mortar) in the base of the toilet. Otherwise, the ceramic may crack due to expansion.
- Never apply a heavy force or impact to the toilet. Do not stand on the seat, lid or main unit. Do not place any heavy objects on the toilet.
- Never clean this product with banana oil, gasoline, chemical and detergent, insecticide, toilet cleaner and hard brush.
- Do not use the water other than the GB 5749 standard tap water. Otherwise, it may cause problems such as system failure or skin irritation.
- Do not expose this product to the sunlight directly, to prevent it from discoloration and compromised remote control function.
- The seat and lid of this product have a feature of slow descent, and do not press them forcibly so as to prevent the descender from being damaged.
- Do not connect the water inlet hose to the water outlet pipe of the water heater, where the inlet water temperature is 3-35°C, and the built-in heating assembly may not work when the temperature exceeds the specified range.
- When using this product, do not lean back on the lid to avoid damaging this product.
- Do not flush objects likely to cause blockage, such as toilet paper, paper urine pad, and maternity sanitary napkins, into the toilet.
- If this product does not work normally or fails, please stop using it and cut off the power supply immediately, and contact the service provider timely.



- Disconnect the power plug and close the water supply valve before installing, disassembling, repairing and maintaining this product.
- Do not use this product in an environment below 0°C. If the room temperature is below 0°C, the water in the water tank must be drained completely to prevent the water tank from freezing and cracking.
- If this product is not used for a long time, the power must be disconnected and the water in the water tank must be drained completely.
- In the event of being used by a person with physical, sensory, intellectual deficiencies or lack of experience and common knowledge (including children), this product needs to be used under the regular supervision of a person. Patients with heart diseases should use this product with caution.
- Do not allow children to play with this product.
- Please provide heating measures to increase the temperature of the washroom in order to prevent frost damages.
- Before use, please drain water and clean the inlet pipe to avoid blockage.

Tools and Materials Required (not supplied)

- Adjustable wrench × 2
- Measuring tape
- Teflon tape
- Utility knife
- Drill
- Sorts of screwdrivers
- Glass cement gun
- Glass cement
- Marking pen
- Level

Dimensions

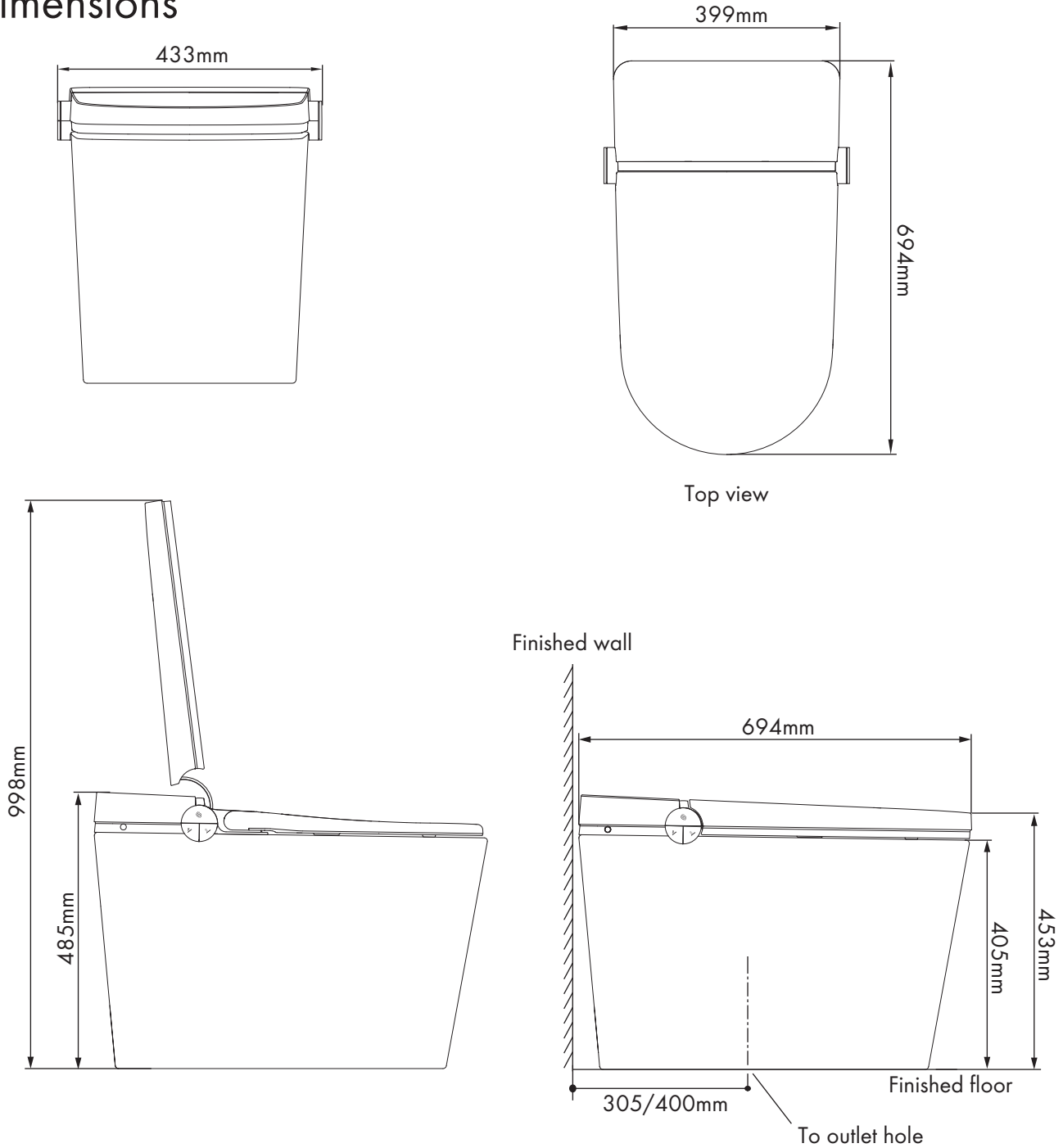

- Notes: 1. The sketch provided in the manual of this product is for reference only, and we reserve the right of modifying the form of this product.
2. If there is any change to the appearance of this product, the actual product shall prevail.

Technical Specifications

Article No.		22452007	22453007	22454007	22455007	22456007	
Model		E		B Auto lid	B		
Rough-in distance		305mm	400mm	305mm	305mm	400mm	
Rated power supply		AC 220V 50 Hz					
*Rated power		1065W		1015W			
length of water inlet hose		appr. 870mm					
length of power cord		appr. 1.5m					
Overall unit waterproof		IP X4					
Ceramic toilet	Flush volume	4.8L (Full 6.0L/Half 4.2L)					
	Water inlet method	Direct to water supply					
	Flushing mode	Siphonic jet					
	Outside diameter of drain outlet	≤100mm					
	Drainage method	Down-drain					
Functional section	Cleaning device	Heating method	Instant heat type				
		Water temperature	Temperature adjusting range: OFF/appr. 32-39 °C				
		Heating power	1600W				
		Water volume	3-Level adjustment				
		Cleansing mode	Rear washing, front washing, mobile washing massage washing	Rear washing, front washing, mobile washing			
		Spray cleansing location	3-Level adjustment				
		Water pressure protection	Pressure stabilizing device, automatic pressure discharging device				
		Anti-fouling device	Automatic spray washing device, anti-siphon device, anti-backflow device, filter device				
		Safety device	Thermal fuse, water temperature sensor, grounding protection, temperature controller, leakage protection				
	Warm wind device	Warm wind temperature	Temperature adjusting range: appr. 43-53 °C				
		Warm wind speed	≥0.2m ³ /min				
		Heating power	210W				
		Safety device	Thermostat, thermal fuse, leakage protection				
	Heated seat	Surface temperature	Temperature adjusting range: OFF/appr. 31-39 °C				
		Heating power	50W				
		Heated burning protection	After 10 minutes of use, the seat temperature automatically decreases to a low level slowly (about 31 °C)				
		Safety device	Seating sensor, temperature sensor, thermal fuse, thermostat, leakage protection				
	Lid opening /closing	Automatic lid opening/closing	●		●		X
		Open/Close by remote controller	●		Open lid only		X
	Caring device	Deodorization mode	Water deodorization		X		X
		eSanitize	●		X		X
		Night light setting	Smart				
		Automatic flushing	Automatic flushing				
Flushing upon power off		Manual flushing					
Inlet water pressure		0.08MPa(hydrodynamic pressure) – 0.8MPa(hydrostatic pressure)					
Inlet water temperature		3°C-35°C					
Ambient temperature		1°C-40°C					
**Bacteriostatic site		Seat、Nozzle、Ceramic glaze					
**UV lamp sterilization site		Spray nozzle					
**Negative Ion Sterilization site		Nozzle、Ceramic flushing surface		X			
Product Dimensions		694 mm (length) × 433 mm (width) × 485 mm (height)					
Product Weight		46kg					
Product Standards		GB 4706.1-2005 / GB 4706.53-2008					

Description:

* Rated power: It is the average power consumed when this product is energized and started initially, sets the water pressure, seat temperature and water temperature to the highest level in sequence, then immediately starts the rear washing and continues to work stably for one cleaning cycle, with the ambient temperature of 23°C, the hydrostatic pressure of 0.18MPa±0.02MPa and the inlet water temperature of 15°C, in accordance with the standard GB 4706.1-2005/GB 4706.53-2008. (In testing, E: Mobile wash and massage clean function must be turned on. B Auto lid and B: Mobile wash function must be turned on.)

** This product meets the sterilization performance requirements in ISO 22196-2011. This product can achieve the removal of Escherichia coli/Staphylococcus aureus.

This product meets the cleaning rate requirements in GB/T 23131-2019.

The optimal cleaning rate test method of this product: needs to adjust the position of the spray wand to the foremost end and the water pressure to the highest level, and turn on the mobile washing function at the same time.

Sketch

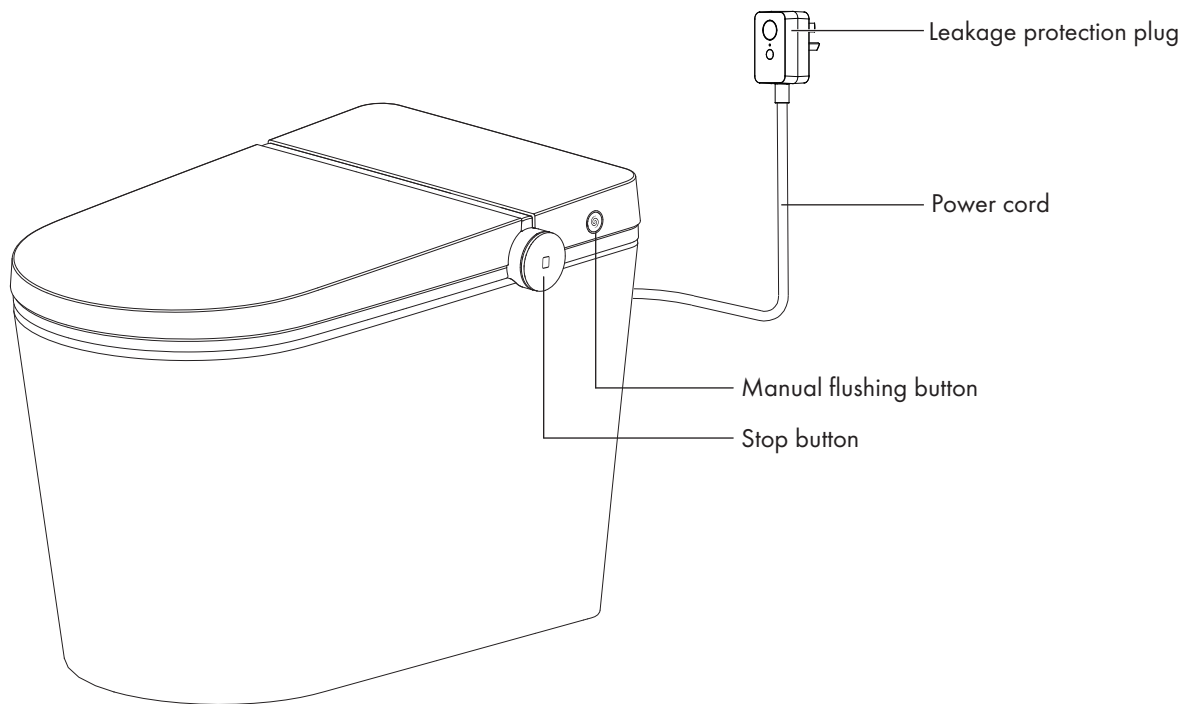
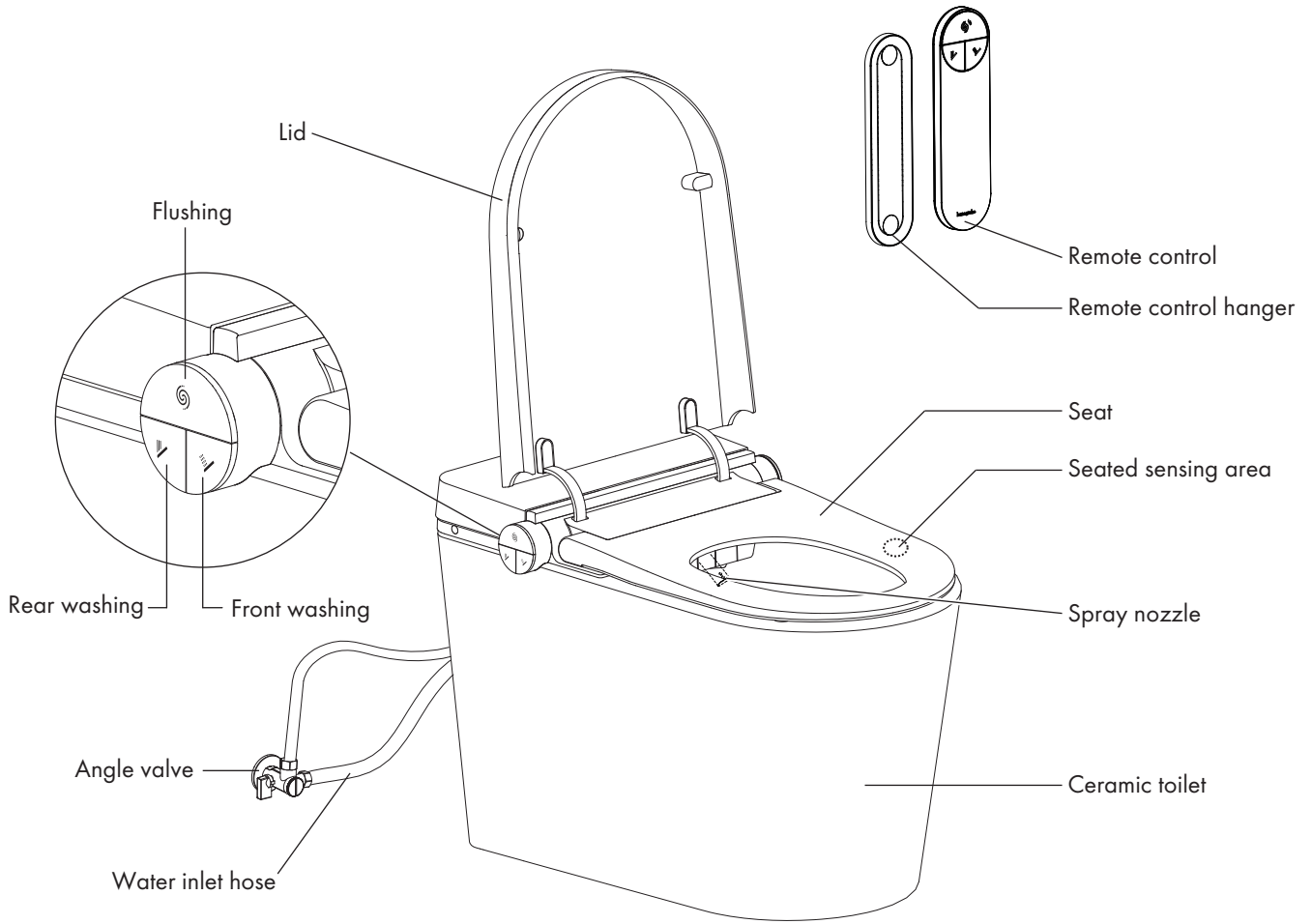

List of Materials

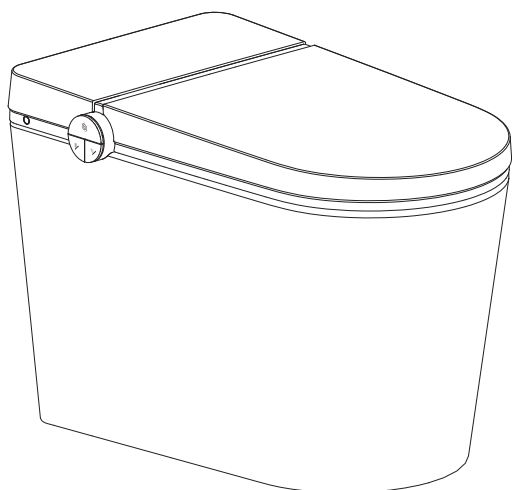

Main unit

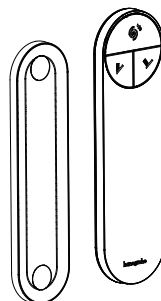

Remote control and Remote control hanger

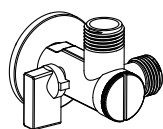

Angle valve



Sealing flange

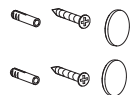

Remote control hanger expansion screw set with silicone



Alignment hole cardboard



Button cell (model CR2450)



Certificate

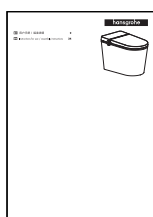

Manual



Warranty card
(included in the manual)

Installation of the ceramic toilet

1. Installation of the mating angle valve

- Tips: 1. If the wall has been installed with the old angle valve, it needs to be replaced by professionals to avoid improper disassembly resulting in the inability to install the angle valve.
2. Must use the matching angle valve, otherwise it may cause the pipeline blockage.

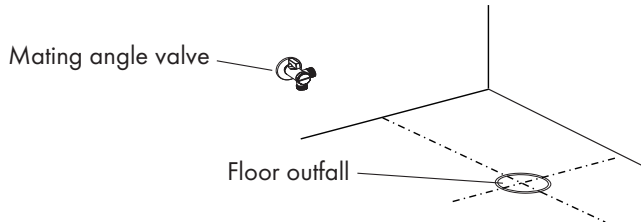

2. Installation of alignment hole cardboard

- Measure the floor levelness with a horizon, to make sure the floor of the installation area is level.
Align the alignment hole cardboard with the center line of the outfall, draw a corresponding contour line based on the alignment hole cardboard, and then remove the cardboard.

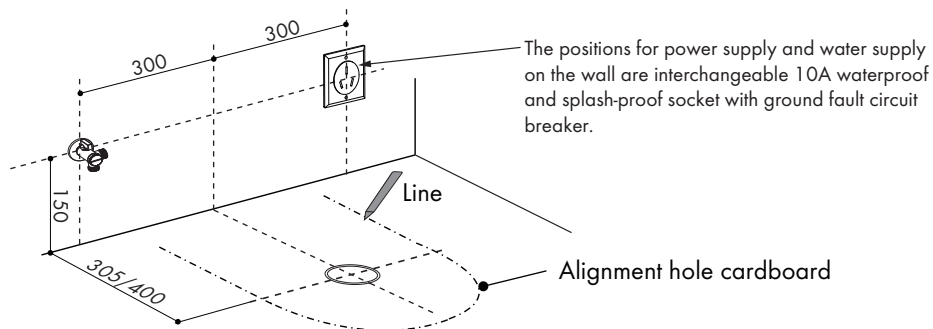

3. Installation of ceramic toilet

- Insert the sealing flange into the drain outlet of the toilet;
Mount the toilet to the corresponding position according to the drawn contour line.

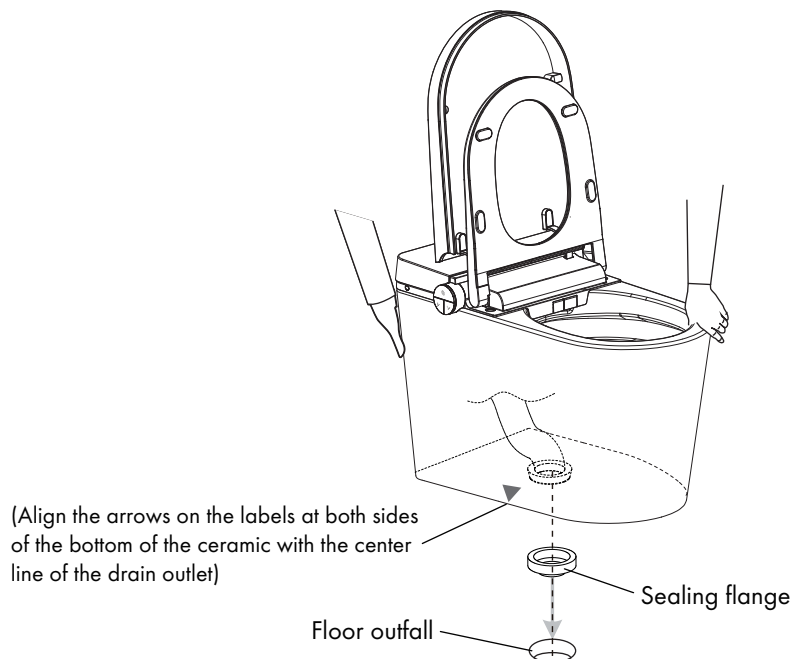

- Tips: It is suggested to lift and open the seat by two persons since the one-piece toilet is heavy.
It is strictly forbidden to carry the product from the seat cover part (it is easy to cause mechanical failure).

4. Installation of water inlet hose

Connect water inlet and angle valve with new hose and tighten them.

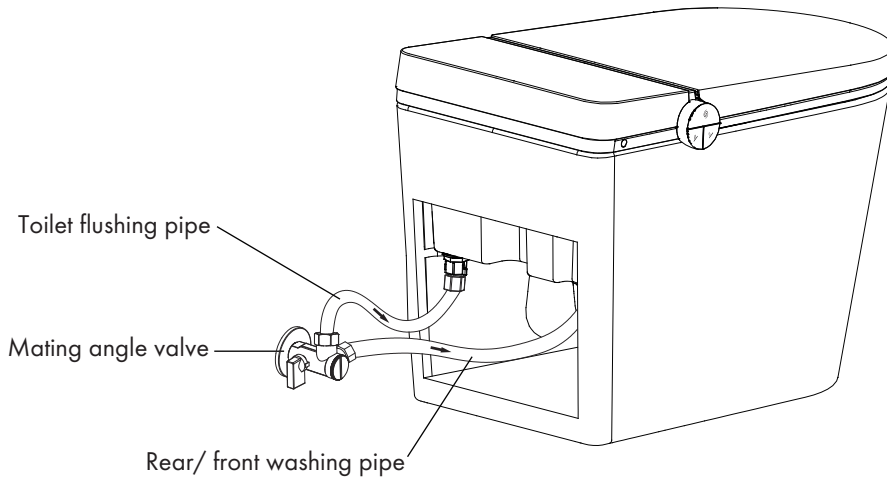

5. Application of the glass glue cement

Apply high-quality mildew-proof glass cement around the lower edge of the toilet.

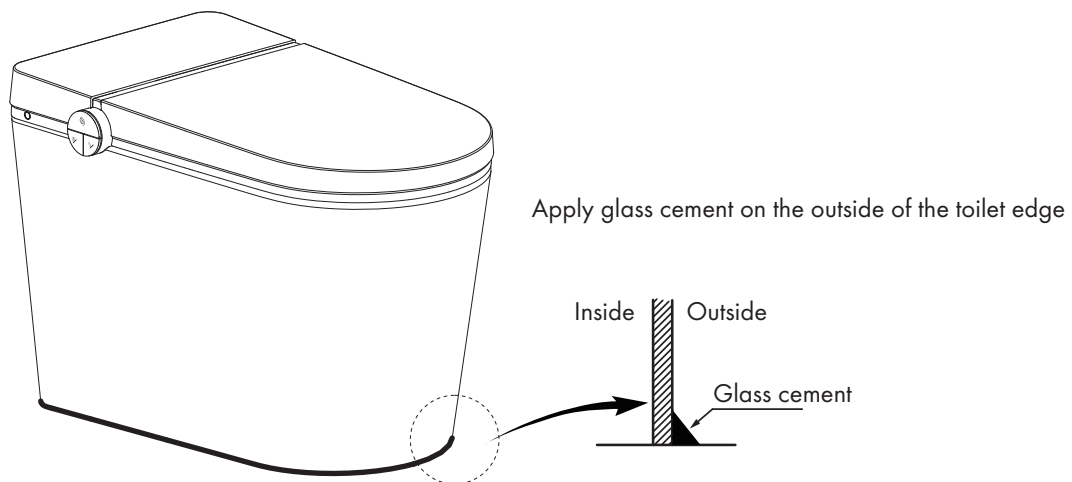

Tips: Clean the garbage and other dirt on drain outlet; and when installing the toilet, make sure the drain outlet of the toilet drain and the floor outfall are installed in place.

Installation of the remote control

Do not install and use this product in a damp environment. Do not place it in a place where it is likely to be damped with water.

1. Installation of remote control hanger

- ① Press the remote control hanger upright against the pre-installation area on the wall, and mark the positions of the two mounting holes on the wall with the marking pen.
- ② Drill holes at the positions marked on the wall with a $\phi 6$ mm drill bit, at a depth of 3.5 mm.
(When determining the installation position, you need to mark sure that a person can easily reach the remote control by hand when sitting on the seat)
- ③ Insert the expansion tubes into the holes in the wall; press the hanger against the wall, with the holes on the hanger aligned with the expansion tubes; insert the screws and tighten them; and then cover them with the silicone pads.

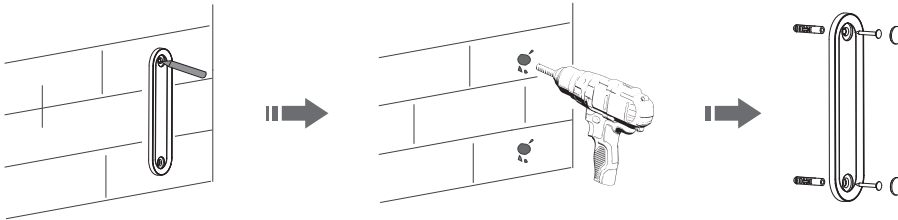

2. Battery installation

- ① Push up the battery cover, open the battery cover.
- ② Unscrew the battery sealing cover counterclockwise, put the new battery with the positive terminal("+") facing upwards into the remote control, and then screw the battery sealing cover clockwise.

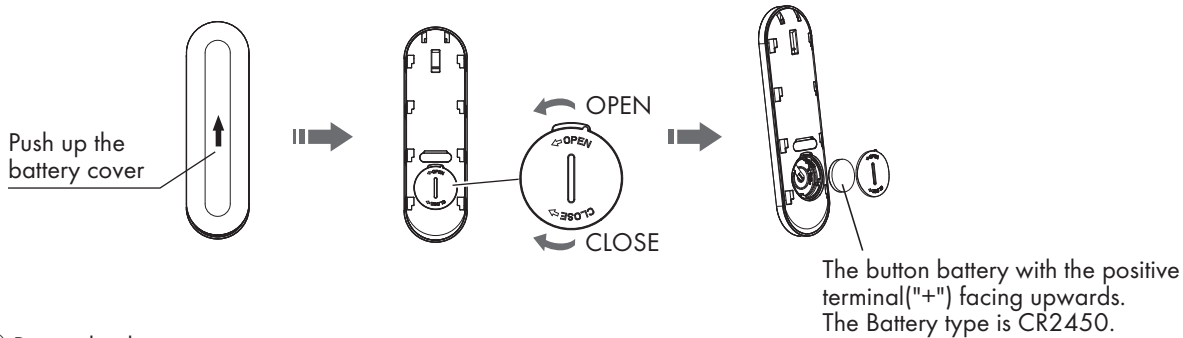

- ③ Put on the battery cover.
- ④ Place the remote control in the hanger (which has a magnetic absorption function).

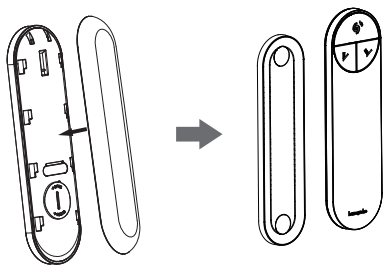

⚠ Precautions for Battery Use

- ① Please use the specified battery type, do not change the battery type at will, otherwise it will lead to product damage, serious can lead to overheating, burning and other safety hazards.
- ② Please recognize the positive and negative pole markings when installing to prevent short circuit and misconnection of positive and negative poles.
- ③ Keep the button battery properly to prevent infants and children from swallowing it.
- ④ Waste button batteries should be disposed of in accordance with national environmental protection laws, do not throw them away.
- ⑤ According to the family of 4 (male:2, female:2), frequency of use: defecating 1 time/day per person, urinating 4 times/day per person. The service life of the button battery is about 6 months. When the battery status indicator of the remote control flashes red, it indicates that the battery is low, please replace the battery in time.

Preparation before Use

1. Turn on the angle valve

To check the tightness of the pipe connections and make sure that there is no water leakage, turn the angle valve counterclockwise to adjust the opening to the maximum.

(Note: The angle valve opens with a large torque for the first time.)

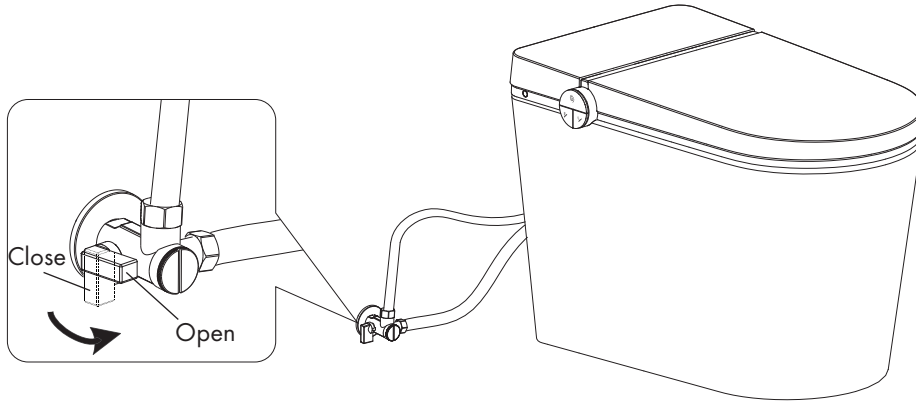

2. Switch on the power supply

Plug the leakage protection plug of the power cord into the power socket, and press the reset button. If the power indicator light is on, it indicates that the power is on.

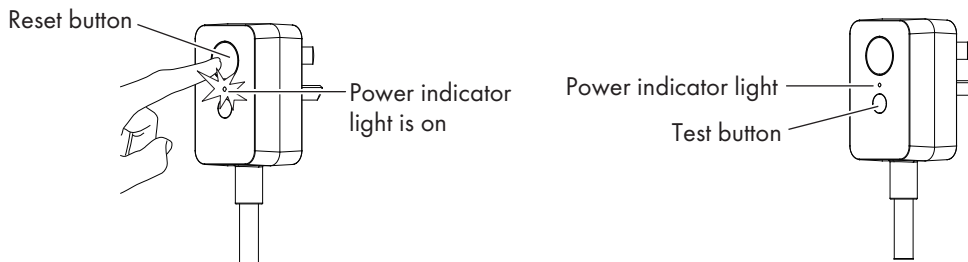

Tips: Press the leakage test button before use. If the reset button bounces, it indicates that the leakage protection function is normal.

3. Safety self-inspection

- ① After power on, the host buzzer beeps, the night light flashes, the side button indicator blue and white light flashes alternately, and the self-test begins.
- ② The host buzzer sounds another "beep", the self-test is completed and stops flashing.
- ③ The function mode is on, and the toilet can be used normally.

Automatic lid opening/closing function

(*Only E 22452007 22453007 and B auto lid 22454007)

If you are purchasing an electronic toilet with automatic lid opening/closing function, it has the feature of automatically opening/closing the lid. (The auto open&close function of lid is set to OFF by default. For the first use, you need to long press the remote control "  "button for more than 3 seconds to open the function. For details, see page 39.)

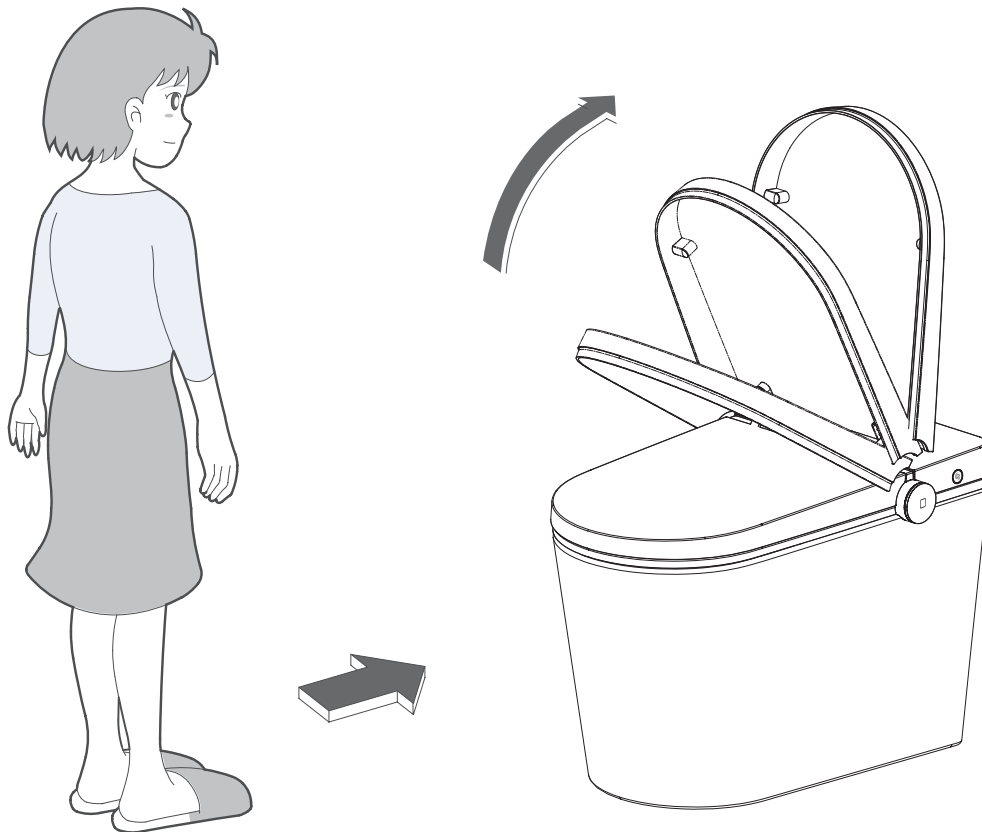

1. When a user gets close to the toilet

When a human body gets close to the toilet, the main unit detects the action of the human body, and opens the lid automatically

2. When using the toilet

The lid will be closed automatically within about 90s after the human body leaves the toilet.

3. When a male user stands to use the toilet

Open the seat with the remote control (Only E) or manually.

The lid and seat will be closed automatically within about 90 seconds after the human body uses and leaves the toilet.

Functional Buttons of Main Unit

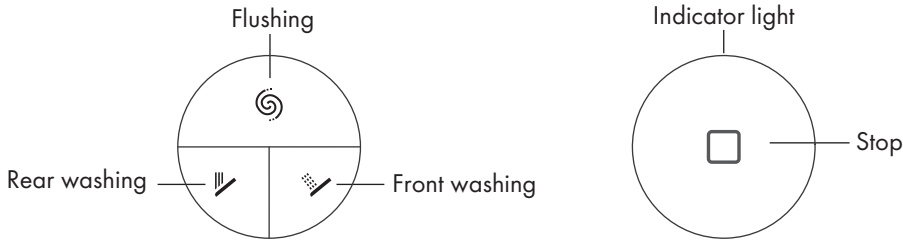

Operation instructions of buttons :

1. When sitting on the seat, short press the "Rear/Front washing" button to activate the Rear/Front washing function, short press the "Stop" button to shut down the function.
2. When leaving the seat, short press the "Rear/Front washing" button to execute the manual cleaning nozzle function, and short press the "Stop" button to shut down the function.
3. When short press the "Flushing" button on the main unit to turn on the flush function.
4. Press and hold the "Rear washing" button and the "Front washing" button simultaneously for more than 3s to turn ON/OFF the automatic power save function. With the automatic power save function activated, the seat heating function will be deactivated when more than 48 hours passes after leaving the seat, and will return to the last level used when sitting on the seat.
5. When leaving the seat, press and hold the "stop" button to enter the standby mode, the white light on the toilet will enter the slow breathing state.
6. In standby mode, press and hold the "Stop" button to exit the standby mode, the white light on the unit is always on.
7. In normal operation mode, when opening the rear wash, front wash, warm wind, cleaning nozzle and other functions, the white light on the toilet is in a breathing state. When the function of negative Ion sterilization is turned on, the blue light on the toilet is in a breathing state.
8. Short press the "stop" button, will stop the rear wash, front wash, warm wind, cleaning nozzle, and negative Ion sterilization functions.

Usage of Remote Control

E

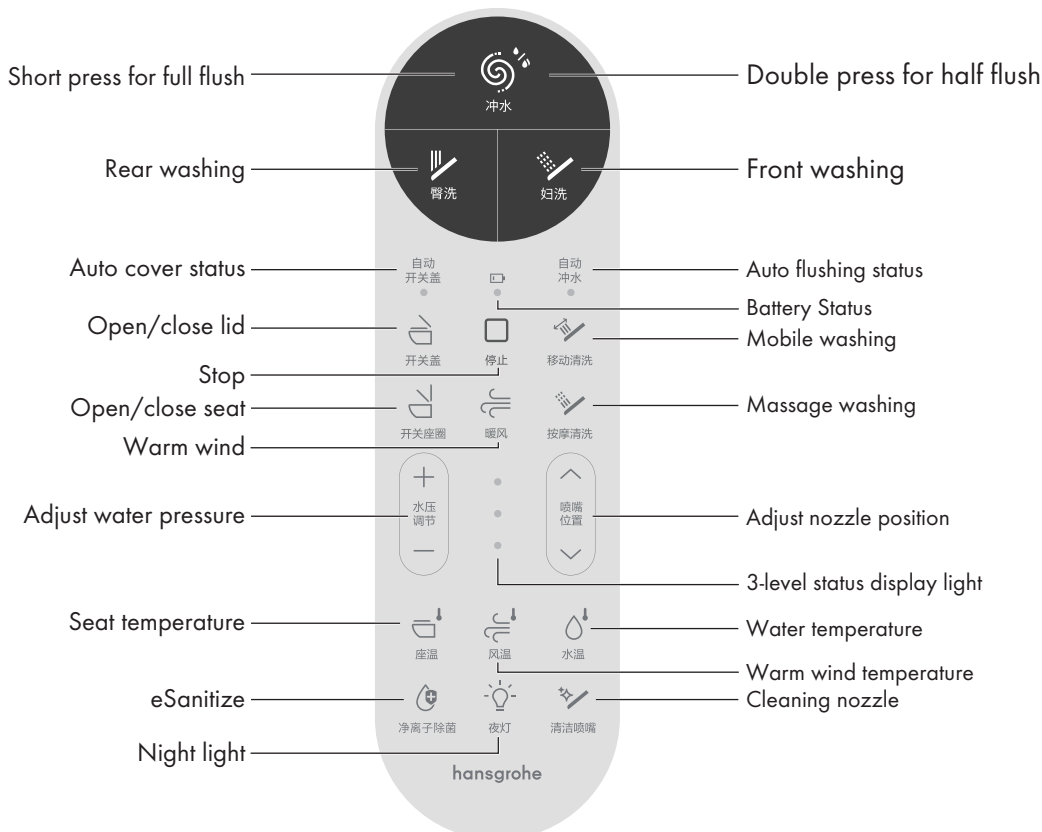

Usage of Remote Control(cont.)

B auto lid

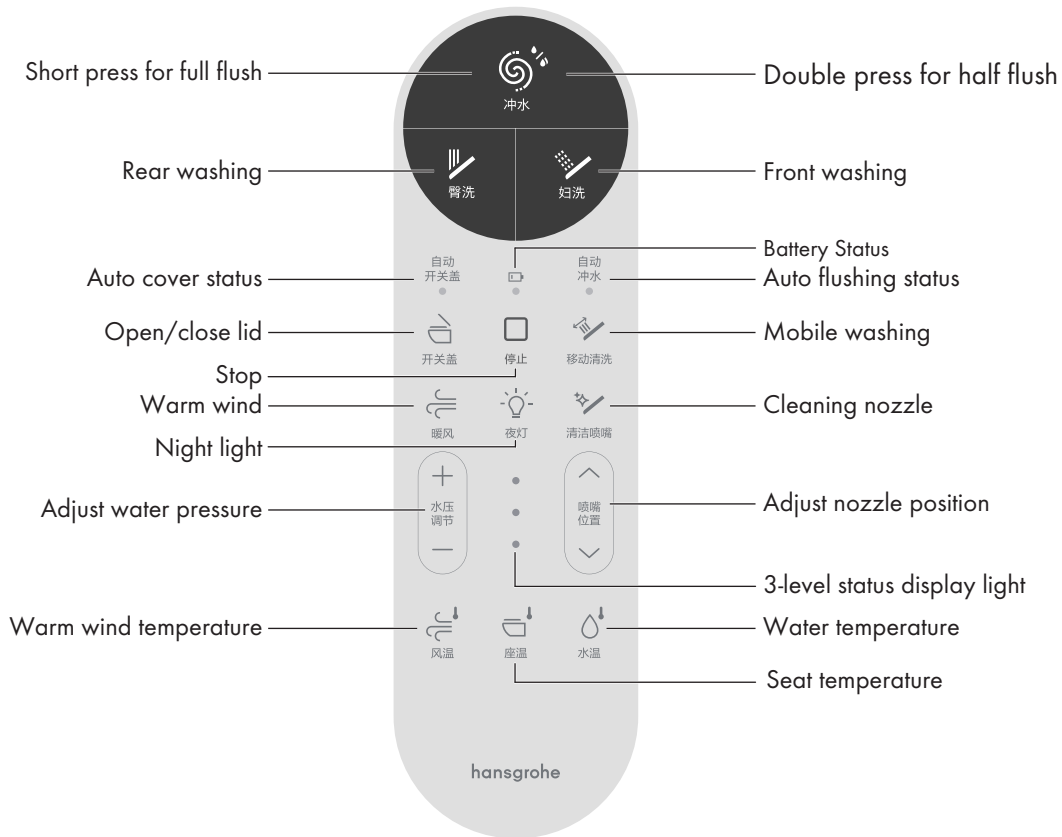

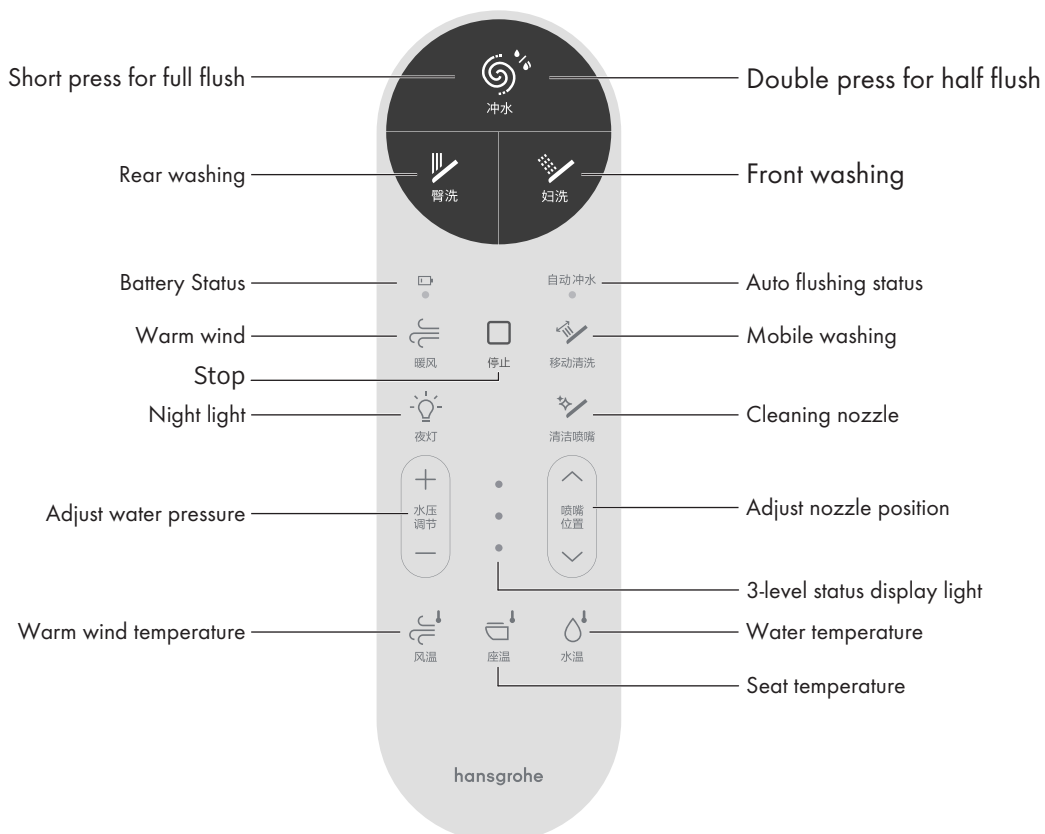

B





Flushing



1. Short press "  " button, the toilet starts full flushing.
2. Double press "  " button, the toilet starts half flushing.
3. Long press "  " button, the automatic flushing indicator light will flash. Press and hold for more than 3 seconds to set the automatic flushing function on or off; when the automatic flushing function is turned on, the automatic flushing status indicator lights up, and no operation indicator goes off within 5 seconds. When the auto flush function is turned on, toilet will automatically flush after detecting user leaving the seat. When the auto flush function is turned on, toilet will automatically flush after detecting user leaving the seat.



Rear washing



In the state of seat, short press the "  " button to open the rear washing function, the spray bar extends and sprays water to clean the buttocks. During the cleaning process, press the "  " button again short or short press the "  " button to stop the rear wash function immediately.

Front washing



In the state of seat, short press the "  " button to open the front washing function, the spray bar extends and sprays water to cleaning. In the process of cleaning, short press "  " button again or short press "  " button can immediately stop the front washing function.

Mobile washing



In the "rear wash" or "front wash", short press the "  " button to open the mobile washing function, the nozzle moves back and forth to expand the washing range.



Massage washing (*E only)



In the "rear wash" or "front wash", short press "  " button to open the massage washing function.



Warm wind



In the state of the seat, short press the "  " button, the warm wind function starts, start the wind. Short press the "  " button again or short press "  " button can immediately stop warm wind.

Open/close lid (*Only E and B auto lid)



- ① Short press "  " button, open or close the lid.
- ② Long press the "  " button, the automatic lid indicator light will flash. Press and hold for more than 3 seconds to set the automatic lid opening and closing function on or off; When the automatic lid opening and closing function is enabled, the automatic lid indicator light will turn on, and if there is no operation within 5 seconds, the indicator light will turn off. (The function is disabled by default and needs to be activated for the first use.)

Open/close seat (*Only E)



Short press "  " button, open or close the seat.

Adjust water pressure



Press " + " or " - " button when it is under rear washing or front washing, the indicator light will be on and showing water pressure level, the water pressure can be adjusted by 3 levels. The indicator light display corresponds to the gear as follows:



Adjust nozzle position



Press " ^ " or " v " button when it is under function of rear washing or front washing, the indicator light will be on showing current nozzle position, adjust nozzle position by 3 levels. The indicator light display corresponds to the gear as follows:



Water temperature adjustment



Short press the "  " button when it is under function of rear washing or front washing to adjust the water temperature. The indicator will show the water temperature level if it's on. When the indicator is off, the water level is 0(normal temperature). Short press this button to adjust water temperature level from 0 to 3 in cycle. The indicator light display corresponds to the gear as follows:

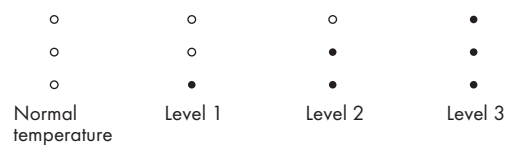

Warm wind temperature adjustment



In the process of drying, press the "  " button to adjust the air temperature, and the indicator light will light up to display the wind temperature range. When the indicator light is not on, it is 0 grade (normal temperature range), and the range adjustment mode is 0-5 grade in turn. The indicator light display corresponds to the gear as follows:

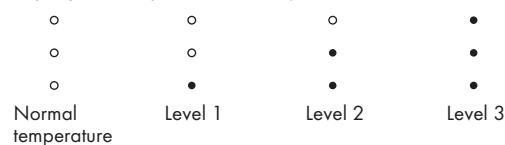

Seat temperature adjustment



Short press the "  " button to adjust the seat temperature. The indicator will show the seat temperature level if it's on. When the indicator is off, the seat level is 0. Short press this button to adjust seat temperature level from 0 to 5 in cycle. The indicator light display corresponds to the gear as follows:

○	○	○	●
○	○	●	●
○	●	●	●
Normal temperature	Level 1	Level 2	Level 3

eSanitize

(*Only E)





① Without seated, short press the "  " button activate the sterilization function for the nozzle and the ceramic interior walls.

② Long press "  " button for more than 3 seconds to enable or disable the automatic negative ion sterilization function. When enabled, the buzzer will beep once, and when disabled, it will beep three times. Once enabled, the nozzle and ceramic interior walls will automatically undergo negative ion sterilization if the net ion sterilization function was not used for 24 hours.

Night light





Short press "  " button to enter into intelligent mode (Night light will be ON or OFF by detecting the lightness of surroundings), the buzzer beeps once;

Short press the "  " button again to turn off the intelligent night light, the buzzer beeped three times.

Cleaning nozzle



Without seated, short press the "  " button, the spray bar extends, open the manual cleaning nozzle, 10 minutes later or short press the "  " button spray bar automatically retracted.

※ In the seated cleaning state, the operation is invalid.





Battery Status



If the battery status indicator flashes red, it indicates that the battery power is low, please replace the remote control battery in time. (Please see page 33 for details on how to operate)

Remote control code pairing

In the power-on state:

- ① Press and hold the "  " button first, then press the "  " button, the indicator flashes.
- ② Within 10 seconds, press and hold the "  " button again, then press the "  " button.
- ③ The indicator light stops flashing and stays on for 2 seconds, the code pairing is successful.

If the remote control does not respond when you use it for the first time, or when you replace it with a new one, you need to re-pair the code to use it normally.

If the code matching fails, please follow the above steps to re-pair the code.

(Remote control code verification must be conducted within 30 seconds after the host is powered on and self tested.)

Tips:

1. Only when the user is seated and the buzzer beeps can the functions of front/rear washing and drying be activated.
2. Please sit backward on the seat for correct washing position and to avoid splashing.
3. The nozzle will continue to spray for 1-2 seconds after user stands up during washing, so please press "Stop" button before standing up.
4. The buzzer will "beep" once when the user presses one button indicating that the main unit receives the signal and conduct the operation accordingly. If the buzzer "beeps" twice, it indicates invalid operation.

Maintenance and Care of Main Unit

1. Cut off the power: Please cut off the power before maintaining the main unit.
2. Wipe with a soft rag: Please wipe the dirty area with a wrung-out soft rag.
3. Safety self-inspection: Please reconnect the power after wiping.
4. If you find that the toilet is moving or shaking during usage, check if the silicone is loosened due to aging, and remove and reapply the silicone if it is loosened.

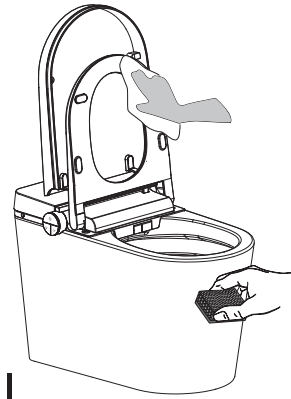

Maintenance and Care of Remote Control

Please wipe the dirty area with a wrung-out soft rag.

- ⊘ Do not to rinse this product directly with water or detergent.

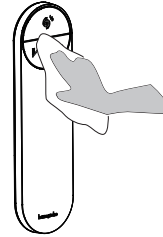

Maintenance and Care of Spray Nozzle

1. Stretch the nozzle: Where there is no human body on the seat, short press "Cleaning nozzle" button of the remote control to activate the manual nozzle washing function. The nozzle will stretch out automatically.
2. Wipe the nozzle: After the nozzle stretches out automatically, wipe it with a soft rag or a soft brush (neutral cleaner); Do not pull out or push in the spray wand to avoid damaging the wand or motor.
3. Retract the nozzle: 10 minutes later or short press the "Stop" button spray bar automatically retracted.

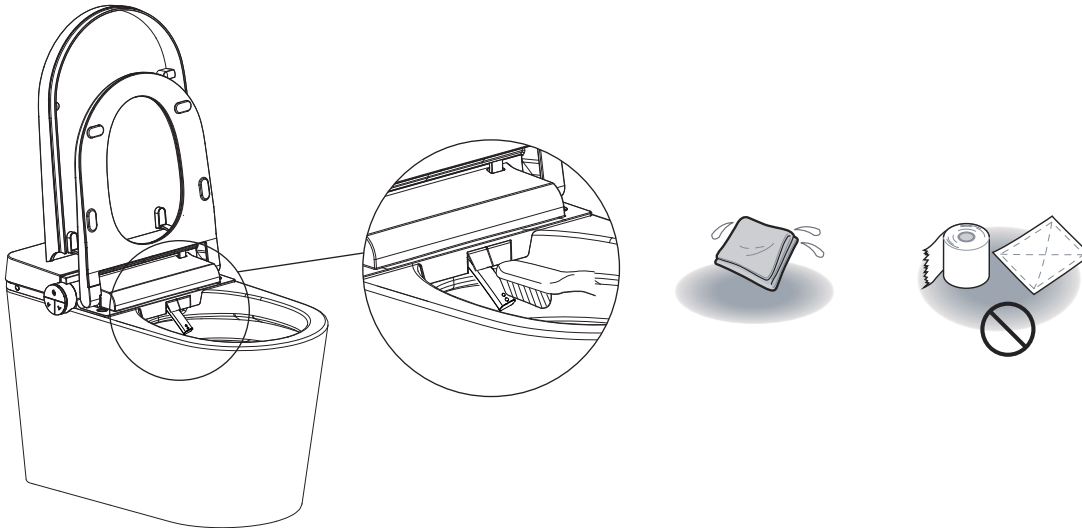

Filter cleaning

Time for maintenance: It is under normal water pressure but poor flush occurs.

1. Close the angle valve, unscrew angle valve nut, remove filter net.

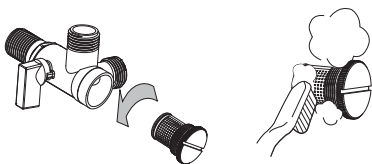

2. Reinstall filter net and angle valve nut, open the angle valve.

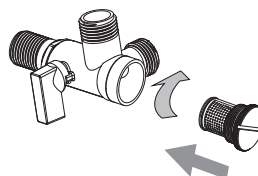

When the electricity and water supply is cut-off

1. How to flush the toilet during interruption of power supply:

Press the manual flushing button (Press and hold for more than 4 seconds) to flush it.

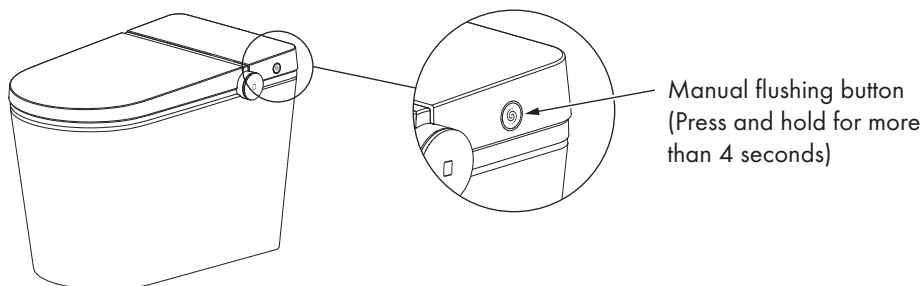

2. How to flush the toilet during interruption of water supply:

Pour the water into a large bucket (about 8 L) and flush the toilet around the bowl face of the toilet. Here, you should take care to prevent water from overflowing from the toilet.

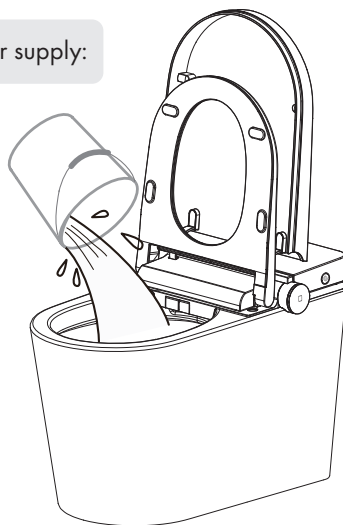

When this product is left unused for a long time

Especially in winter, when you are not at home for a long time, please make sure to drain the water in the water tank and the pipeline to prevent freezing.

To discharge water:

1. Unplug and cut off the electricity.
2. Drain out the water inside tank:
Close the water inlet angle valve and long press the manual flushing button to drain the water.
3. Drain the water in the pipeline:
loosen the hose from the angle valve, drain the water in the pipeline and reinstall the hose.



4. Dispose of the water in the toilet:
For the sake of safety, it is recommended to pour the antifreeze into the water in the toilet.

**Tips: Before drainage, you must cut off the power!
When using the toilet again, please make sure to turn on the water and power again.**

Fault Analysis and Solution

Problem	Cause	Solution
No flushing	The water inlet hose buckles to cause blockage	Solve the buckling
	The fill valve is off	Turn on the fill valve
	Water supply is cut off	Wait for water supply restoration
Poor flushing	The water inlet hose buckles to cause partial blockage	Solve the buckling
	The fill valve is not fully turned on	Turn on the fill valve fully
	Filter blockage	Replace the filter
Low water temperature	The water temperature is set at the normal temperature level	Reset the water temperature
Low seat temperature	The seat temperature is set at the normal temperature level	Reset the seat temperature
	In standby or power save mode	Switch to the function mode and use it after 3 minutes
Low wind temperature	The wind temperature is set at the normal temperature level	Reset the wind temperature
No wind out	In standby mode	Switch to the function mode to use the warm wind function
The spray wand cannot retract	Power off	Push back the spray wand lightly and wait for the power
	Get stuck by impurities	Clear away the impurities, or gently push the spray rod back
The spray wand cannot stretch out	Power off	Wait for power restoration
	Not sitting in the sensing area	Sit right in the sensing area
The remote control is failed	Reverse the polarity of battery	Reinstall the battery with correct polarity setting
	Remote control battery low	Replace with a new battery
The deodorization does not function normally (*E only)	The user doesn't reach the sensing area in the seat	Adjust to reach the sensing area in the seat
	Deodorization function keeps working after the user leaves	After the user leaves the seat, the deodorization function will continue working for a while to make sure to eliminate the odor completely, which is normal
 Caution	If the fault still exists after taking the measures above, you should cut off the power, and contact the service provider to ask a professional to repair it.	
	If the power leakage protection switch often trips, this product is indicated to undergo electric leakage. Please cut off the power, and contact the service provider to ask a professional to repair it.	

Information on the Use of Hazardous Substances in Electrical and Electronic Devices

Part Name	Hazardous Substance					
	Lead (Pb)	Mercury (Hg)	Cadmium (Cd)	Hexavalent chromium (Cr(VI))	Polybrominated biphenyl (PBB)	Polybrominated diphenyl ether (PBDE)
Power cord	×	○	○	○	○	○
Circuit board	×	○	○	○	○	○
Seating sensor	×	○	○	○	○	○
Temperature sensor	×	○	○	○	○	○
Temperature protector	○	○	×	○	○	○
Grounding piece	×	○	○	○	○	○
Water inlet hose	×	○	○	○	○	○
Expansion bolt	×	○	○	○	○	○
Angle valve	×	○	○	○	○	○
Stabilizer assembly	×	○	○	○	○	○
Motor assembly	×	○	○	○	○	○

○:It indicates that the content of this hazardous substance in all the homogeneous materials of this component is below the limit specified in GB/T 26572.
 ×:It indicates that the content of this hazardous substance at least in a homogeneous material of this component is above the limit specified in GB/T 26572.

Environment-Friendly Use Period 

The number of years in this symbol is based on the environment-friendly use period provided in SJ/T 11364-2014 Marking for the Restriction of the Use of Hazardous Substances in Electronic and Electrical Products.

As long as the safety and use precautions of this product stated in the manual are observed, the leakage or sudden change of hazardous substances due to the use of this product will not occur during this period from the date of manufacture, and the serious pollution to the environment and the injuries and property losses to the user will not be caused.

[Environment-Friendly Use Period] It is neither a safety service life nor a quality guarantee period. When this product is not suitable for continued use and needs to be discarded, please dispose it in accordance with the legal regulations related to the recycling of electrical and electronic products. Thank you for your cooperation.

Note: The product you have purchased may not contain all of the components above, which depends on the product model.

Grade of the energy efficiency and water efficiency

The energy efficiency and water efficiency grades of Hansgrohe's smart toilet products meet the requirements of GB 38448 "Minimum allowable values and grades of the energy efficiency and water efficiency for smart water closets". The energy efficiency and water efficiency grade indicators of smart water closets are as follows:

Grades of energy efficiency and water efficiency for smart water closets			Grade 1	Grade 2	Grade 3
Energy efficiency grade indicator	Energy consumption per unit cycle (kW·h)	With heated seat	≤0.030	≤0.040	≤0.060
		Without heated seat	≤0.010	≤0.020	≤0.030
Water efficiency grade indicator	Average water consumption for cleaning (L)		≤0.30	≤0.50	≤0.70
	* Average water consumption for flushing (L)		≤4.0	≤5.0	≤6.4
	* Average water consumption for full flushing of dual-flush toilet (L)		≤5.0	≤6.0	≤8.0

Note 1: "*" is applicable to integral smart toilets.

Note 2: In each water efficiency level, for the dual-flush smart toilet, the average water consumption of half flush is not greater than 70% of its maximum limit value of full flush.

(Note: For the actual energy and water efficiency grade of the purchased product, please refer to the energy and water efficiency grade indicated on the product or package)

Warranty Card

Model No.		Customer Name	
Seller		Purchasing Date	
Invoice No.		Customer Contact No.	
Distributor Stamp		Distributor Contact No.	

Thank you for purchasing our product! To maintain our product reputation and protect your consumer rights, we will provide you with one-year (for the electric appliance) or five-year (for the ceramic section) free warranty service. After successful registration in the official platform, the electric appliance will get an extended warranty of one year, if the product is for commercial use, the whole product will be warranted for a period of one year. Please feel free to use.

Where this product malfunctions when you use it normally according to the manual and precautions for use, it can be repaired free of charge during the warranty period. Where this product needs to be repaired due to faults during the warranty period, you can contact our company with the warranty card and the original invoice for free repair or replacement (it may be replaced with a similar model if the same model is not available, and we reserve this right).

In the event of exceeding the warranty period or losing the warranty card, we also provide you with a repair service, which will be charged at cost.

This limited liability applies only to mainland China (excluding Hong Kong, Macau and Taiwan).

The undertaking of the limited liability for the product of our company applies to our product purchased by you, and the repairs will be charged during the warranty period under the following conditions:

1. Damages caused by improper use, maloperation or improper repair or modification.
2. Damages caused by moving the installation location.
3. Damages caused by fires, earthquakes, floods, lightning strikes, freezing and other natural disasters, public nuisances and gas disasters, sulfuric acid, hydrochloric acid, and abnormal voltage.
4. Damages caused by the use of power sources other than the specified power source (voltage, frequency).
5. Damages caused by the uses other than the general household or hotel uses.
6. Damages caused by improper uses incurred from silting-up sand and dirt and consumables such as packaging.



National Service Hotline: 400-820-3555

To protect your service rights, please scan the code and register
the product in time after installation.

hansgrohe

Hansgrohe · Auestraße 5 - 9 · D-77761 Schiltach · Telefon +49 (0) 78 36/51-1282 · Telefax +49 (0) 7836/511440
E-Mail: info@hansgrohe.com · Internet: www.hansgrohe.com

06/2023
90958751