

ZH 组装说明

EN Assembly instructions

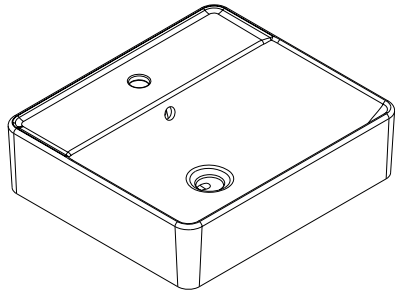

LakeShore Q 500

22439007

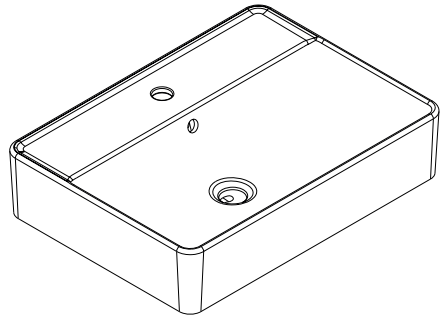

LakeShore Q 600

22440007

安装之前

- 留意当地所有给排水及建筑规定。
- 检查污水管及供水管，如有需要请更换。
- 安装之前，先开启新脸盆的包装，并小心检验新的脸盆是否有损坏，再将脸盆放回包装盒内，到安装时才取用。
- 若为更换新脸盆，须确保现有的柜台孔口与新脸盆的切割位相同或较后者小。
- 请使用同时印在此说明书上的切割图，标划正确之切割位。
- 汉斯格雅洗脸盆是根据德国标准制造的，与欧式洗脸盆配件相配。其它洗脸盆配件可能与之不相配。

BEFORE YOU BEGIN

- Observe all local plumbing and building codes.
- Inspect the waste and supply tubing; replace if necessary.
- Prior the installation, unpack the new lavatory and carefully inspect for damage. Return the lavatory to its protective carton until you are ready to install it.
- For replacement installations, make sure the existing cutout is the same or smaller size as the new lavatory.
- Use the template supplied with the lavatory to mark correct size cutout.
- Hansgrohe lavatory is made according to Germany National Standard that it can match the Germany lavatory fittings. Any other lavatory fittings may not fit for hansgrohe lavatory.

所需工具及物料

(不随货供应)

- 模板 (已提供)
- 护眼镜
- 炭笔
- 剪刀
- 卷尺
- 涂油灰刀
- 水管用油灰
- 钢锯
- 匙孔线锯或手提电锯
- 钻 (直径为 13 mm 钻头或更大)
- 活动板钳
- 喉管板钳
- 切管刀

TOOLS AND MATERIALS

(Not Supplied)

- Template (supplied)
- Safety glasses
- Pencil
- Scissors
- Tape measure
- Putty knife
- Plumbers putty
- Hack saw
- Keyhole saw or saber saw
- Drill (13 mm or 1/2" dia. drill bit or larger)
- Adjustable wrench
- Pipe wrench
- Tubing cutter

尺寸图

Unit:mm
单位:毫米

LakeShore Q 500 22439007

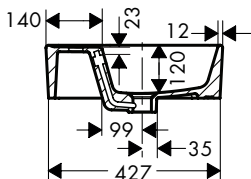
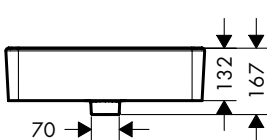
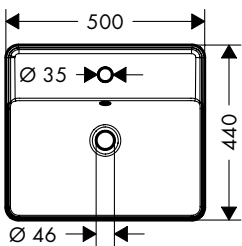

ROUGHING-IN

Reference Value
参考值

LakeShore Q 600 22440007

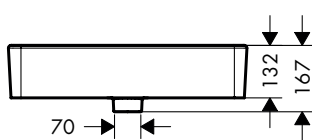
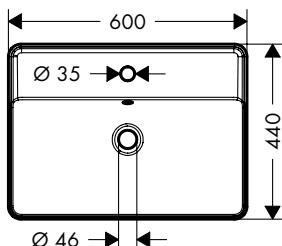

汉斯格雅公司保留随时变更图中标示尺寸的权利, 无需另行通知。

hansgrohe reserves the right to change marked dimensions without prior notice.

拆除旧脸盆

REMOVE EXISTING LAVATORY

- 关掉水龙头的供水源。
- 打开龙头阀门, 然后除开供水管。
- 再旋开排水装置, 并拿开弯管。
- 移走旧脸盆。
- Turn off the water supply to the faucet.
- Open the faucet valves, then disconnect the supply lines.
- Disconnect the drain assembly and remove the trap.
- Remove the existing lavatory.

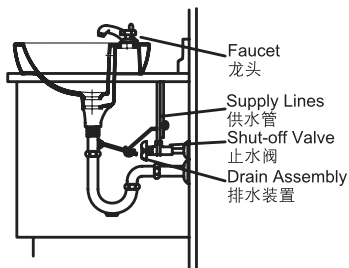

安装新脸盆

INSTALL NEW LAVATORY

- 将切割图沿切割线切出。
- 将切割图放在盥洗台上，确保脸盆、水龙头和防溅挡板之间有足够距离。
- 查核盥洗台下的储物柜也有足够空间。
- Cut the template on the cutout line.
- Position the template on the countertop to ensure clearance between the lavatory, faucet, and backsplash.
- Verify cabinet clearance beneath the countertop.



图 1



图 2

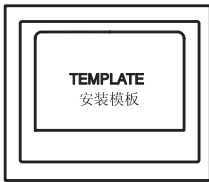

图 3

- 用炭笔沿切割图在盥洗台面划线。(图2)
- 再次检查脸盆、水龙头、防溅挡板及储物柜的空间及距离。如有需要可调校切割图的位置。
- 用一个13 mm的钻头，在切割口内侧钻一个导孔。(图3)
- 沿着自切割图勾划出来的铅笔线内侧切开台面。
- 暂将脸盆放入台面开口，校正位置。
- Trace the template on the countertop with a pencil.
- Re-check the clearance between the lavatory, faucet, backsplash, and cabinet. Adjust the template accordingly.
- Drill a 13 mm hole on the inside of the cutout opening.
- Cut the opening in the countertop along the inside edge of the pencil line.
- Temporarily position the lavatory in the opening, and adjust to fit.

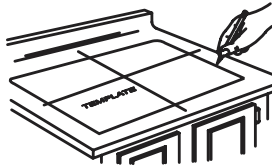

小心：提防身体受伤或损坏产品。因大型脸盆相当重，需找人帮您一起搬动及安放。

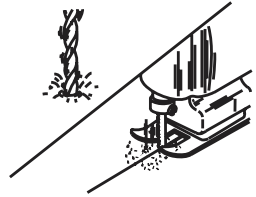

CAUTION: Risk of personal injury or product damage. Large lavatories are very heavy. Get help lifting the lavatory into place.



图 4

- 用炭笔沿脸盆外缘在盥洗台上划线。(图4)
- 然后将脸盆移开。
- 按照制造商的指引，安装水龙头和排水管道。
- 沿炭笔导线内侧涂两滴封边胶。
- 用涂油灰刀将其抹匀。(图5)
- 小心地将脸盆置于台面切口适当位置，向下按牢。(图6)

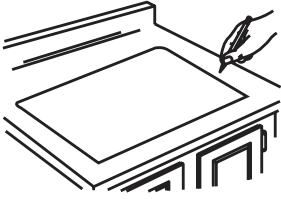

图 6

- 立即擦去多余的封边胶，如脸盆外缘与台面间有缝隙，即用胶填密。
- 检查脸盆的位置准确。

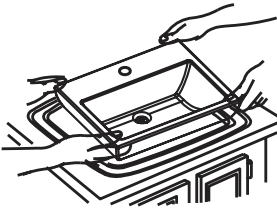

图 5

- Trace a pencil line around the outside edge of the lavatory.
- Remove the lavatory.
- Install the faucet and drain according to the manufacturers instructions.
- Apply two beads of sealant to the inside of the pencil line.
- Spread the sealant evenly with a putty knife.
- Carefully position the lavatory in the cutout, and press down firmly.

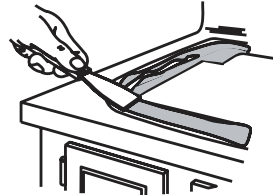

图 7

- Immediately wipe away any excess sealant, and fill any voids as needed.
- Verify that the lavatory has not moved out of position.

- 最少待三十分钟，让封边胶干透后，方可继续进行安装。
- 联接水龙头供水管。
- 联接排水装置。
- 开启水龙头阀门，检查有否渗漏。
- 用非腐蚀性清洁剂来清洁。



小心：提防身体受伤或损坏产品。因大型脸盆相当重，需找人帮您一起搬动及安放。

- Allow the sealant to cure for at least 30 minutes before proceeding.
- Connect the faucet supply lines.
- Connect the drain assembly.
- Open the faucet valves, and check for leakage.
- Clean up with a non-abrasive cleaner.



CAUTION: Risk of personal injury or product damage.
Large lavatories are very heavy. Get help lifting the lavatory into place.

用户须知 (护理和清洁)

IMPORTANT CONSUMER INFORMATION (CARE AND CLEANING)

为保持脸盆光洁如新，须确保每次使用后彻底冲洗干净，切勿使用腐蚀性的清洁剂，以免刮花及破坏脸盆的表面。要清除顽固污垢，油漆或柏油，可使用松油或油漆稀释剂。

To keep your lavatory looking new, make sure you rinse it out thoroughly after each use. **DO NOT USE ABRASIVES** on this product, as they will scratch and ruin the surface. Stubborn stains, paint, or tar can be removed with turpentine or paint thinner.

不要在0°C以下的水环境中使用。

Do not use the product in the water below 0°C.



警告：请勿使用钢丝球等硬质材料擦洗产品表面，特别是产品商标处。



CAUTION: Please do not use hard materials (like scouring pad) to clean product surface, especially the product logo.

产品保修卡

产品型号		客户姓名	
销售单位		购买日期	
发票号码		客户电话	
经销商盖章		经销商电话	

感谢您购买本公司产品! 为确保产品信誉及维护您的消费权益, 自购买日起 (以购买单据日期为准), 本公司将为您提供免费的保修服务: 陶瓷产品整机三年, 官方服务平台注册成功后, 延保二年, 如产品用于商业用途整机保修一年, 敬请放心使用。

按照说明书和使用注意事项正常使用后发生故障时, 在保修期内免费维修。保修期内因故障要求维修时, 可凭保修卡和原始发票与本公司联系, 进行免费维修或更换 (如果没有同样的型号则以类似型号代替, 本公司保留此权利)。

如果超过保修期或遗失保修卡, 本公司也提供维修服务并收取成本费用。

该有限责任仅适用于中国大陆 (不包括香港、澳门、台湾)。

本公司产品的有限责任承担适合购买的本公司产品, 保修期内以下情况下进行收费维修:

1. 因使用不当, 误操作或者不正当的修理改造而造成的损坏。
2. 移动安装位置所造成的损坏。
3. 由火灾、地震、水灾、雷击、冰冻及其他自然灾害, 公害和气体灾害、硫酸、盐酸、异常电压引起的损坏。
4. 用于一般家庭或者酒店以外的用途, 所发生的损坏。
5. 因淤积的沙土、污物而产生的使用不良及包装等易耗品造成的损坏。

Warranty Card

Model No.		Customer Name	
Seller		Purchasing Date	
Invoice No.		Customer Contact No.	
Distributor Stamp		Distributor Contact No.	

Thank you for purchasing our product! To maintain our product reputation and protect your consumer rights, we will provide you with three-years (for the ceramic section) free warranty service. After successful registration in the official platform the electric appliance will get an extended warranty of two years , if the product is for commercial use, the whole product will be warranted for a period of one year. please feel free to use.

Where this product malfunctions when you use it normally according to the manual and precautions for use, it can be repaired free of charge during the warranty period. Where this product needs to be repaired due to faults during the warranty period,you can contact our company with the warranty card and the original invoice for free repair or replacement(it may be replaced with a similar model if the same model is not a vailable, and we reserve this right).

In the event of exceeding the warranty period or losing the warranty card, we also provide you with a repair service, which will be charged at cost.

This limited liability applies only to mainland China (excluding Hong Kong, Macau and Taiwan).

The under taking of the limited liability for the product of our company applies to our product purchased by you, and the repairs will be charged during the warranty period under the following conditions:

1. Damages caused by improper use, maloperation or improper repair or modification.
2. Damages caused by moving the installation location.
3. Damages caused by fires, earthquakes, floods, lightning strikes,freezing and other natural disasters, public nuisances and gas disasters, sulfuric acid, hydrochloric acid, and abnormal voltage.
4. Damages caused by the uses of her than the general household or hotel uses.
5. Damages caused by improper uses incurred from silting-up sand and dirt and consumables such as packaging.