

**ZH** 组装说明

**EN** Assembly instructions

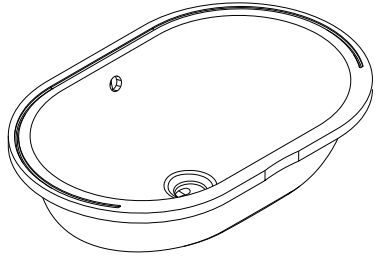

**LakeShore U 530**

22441007

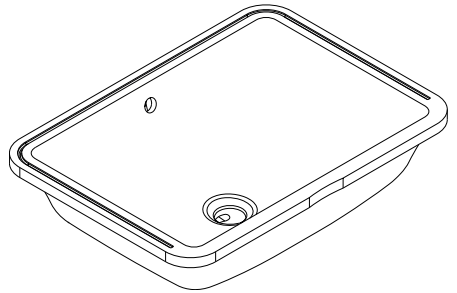

**LakeShore Q 500**

22443007

## 安装之前

## BEFORE YOU BEGIN

- 有关安装属专业性质，故盥洗台下脸盆必须经由受过训练及有经验的技师进行安装。
  - 切勿在台盆与大理石之间使用胶黏剂或有黏性的密封胶。
  - 检查出水及供水管道，如有需要便更换。
  - 安装之前先开启新脸盆的包装，检查有无损毁后放回纸箱中以免碰坏，到准备安装时才取用。
  - 遵守当地所有给排水及建筑规定。
  - 本产品符合GB/T 6952-2015。
- Due to the nature of the installation, undercounter lavatories should be installed by trained and experienced installers.
  - Do not use adhesives or adhesive sealants between marble countertop and lavatory.
  - Inspect the waste and supply tubing; replace if necessary.
  - Prior to installation, unpack the new lavatory and inspect it for damage. Return the lavatory its protective carton until you are ready to install it.
  - Observe all local plumbing and building codes.
  - The product complies with GB/T 6952-2015.

## 所需工具及物料

## TOOLS AND MATERIALS

### (不随货供应)

### (Not Supplied)

- 封边胶
- 炭笔
- 卷尺
- 尖刀或剪刀
- 匙孔线锯或手提电锯
- 钻(直径1/2英寸或更大的钻咀)
- 防护眼镜
- 锤子
- 抹布或抹手纸
- 高强度AB胶
- 玻璃胶

- Sealant
- Pencil
- Tape measure
- Sharp knife or scissors
- Keyhole or saber saw
- Drill (1/2" dia. drill bit or larger)
- Safety glasses
- Hammer
- Rags or paper toweling
- Strong AB sealant
- Glass cement

注意：若盥洗台的物料并非木或木质合成品，则你可能需要在安装脸盆时使用其他更专门的工具。

You may require different, more specialized tools to install this lavatory to countertop materials other than wood or wood composites.

## 尺寸图

Unit:mm  
单位:毫米

### LakeShore U 530

22441007

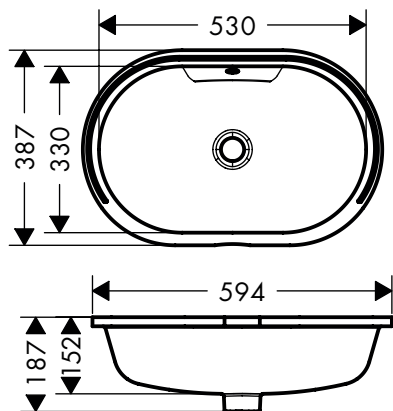

## ROUGHING-IN

Reference Value  
参考值

### LakeShore Q 500

22443007

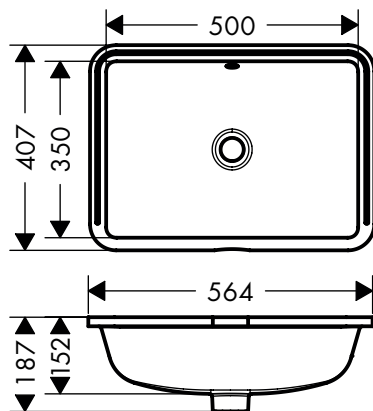

Note: waterproof unprotected overhang area on the underside of wood counter.  
注: 木质盥洗台面板下突出部份须作防水处理。

## 安装脸盆

注意: 安装中要允许将来可以从盥洗台面之下进行拆装, 以免台面损坏。

- 检查准备装上脸盆的位置, 是否与防溅挡板、水龙头、脸盆及储物柜保持足够的距离。
- 剪出模板。
- 将模板小心放置于台上, 并在台面上按照模板画出其边缘轮廓导线。
- 在盥洗台上标出水龙头孔位的中心线。
- 在切线内侧钻出一个13毫米的导孔。
- 用匙孔线锯或者手提电锯切开盥洗台面。

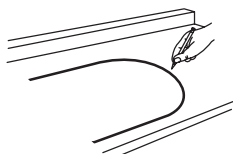

## INSTALL LAVATORY

**NOTE:** Install so future removal from underneath the countertop is possible to avoid damage to the countertop.

- Check the desired lavatory location for clearance between the backsplash, faucet, fixture, and cabinet.
- Cut out the template.
- Carefully position and trace the template on the countertop as directed on the template.
- Mark the faucet hole centerline on the countertop.
- Drill a 13mm pilot hole on the inside of the cut line.
- Cut out the countertop opening with a saber or keyhole saw.

## 木制盥洗台

## FOR WOOD COUNTERTOPS

- 按照模板所示的位置，在台面标出及预先钻妥木螺钉的孔位。
- 其它外露的木质表面需要保持防水。

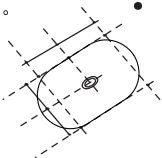

- Mark and pre-drill the wood screw holes at the locations shown on the template.
- Waterproof any exposed areas of wood.

## 大理石盥洗台

## FOR MARBLE COUNTERTOPS

- 清洁台面和定位块，并保持干燥。
- 取高强度A、B胶若干，按1:1搅匀。
- 将螺丝放入定位块中间的孔内，并将搅匀的胶水涂抹在定位块上。
- 将定位块按位置与台面粘合。

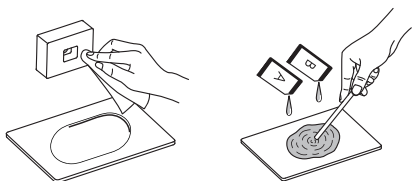

- 固定定位块，并与盆边保持5mm以上的距离。
- 2小时后将盆放好，拧紧螺母，沿盆边打好硅胶。
- 24小时内勿承重物。

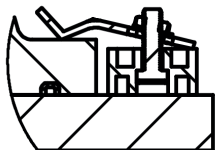

- Clean the countertop and block. Keep them dry.
- Take same amount of strong A and B sealant and mix them up.
- Insert the screw into the hole on middle of the block and then apply the mixed sealant onto the block.
- Glue the block to the countertop as shown.

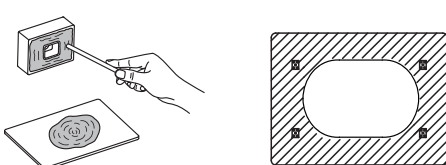

- Fix the block and keep at least 5mm from the edge of the lavatory.
- Place the lavatory after 2 hours. Tighten the screw and apply silicone sealant around the edge of the lavatory.
- Keep away from heavy objects within 24 hours.

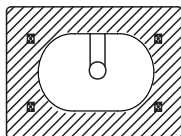

## 所需台面的安装

## FOR ALL INSTALLATIONS

- 如还未安装盥洗台，请在这时装上。
- 按照龙头安装说明书钻龙头孔。
- 按照制造商的说明书，在盥洗台上装水龙头。
- 按照制造商的说明书，在脸盆下装上排水管。

注意：请勿在本品上使用干燥后有收缩性的胶黏剂，如云石胶等。

- 在与盥洗台接触的脸盆边缘，如珠串般滴上优质密封胶，如玻璃胶等。

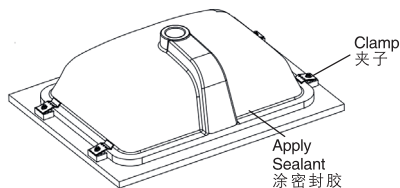

注意：

- 大理石材质的盥洗台，使用随附的夹子组件。
- 木、木质合成物的盥洗台(厚度25毫米以上)，可另行购买夹子组件(94801000)。
- 其它材料制造的盥洗台，则请参考盥洗台制造商说明书上的建议，使用适当的扣件。

- If the countertop has not been installed, install it at this time.
- Drill the faucet holes according to the faucet installation instructions.
- Install the faucet to the countertop according to the manufacturer's instructions.
- Install the drain to the lavatory according to the manufacturer's instructions.

**NOTE:** Please do not use sealant with contractility after drying, such as marble adhesive.

- Apply a continuous bead of quality sealant to the lavatory rim where it will contact the countertop, such as glass cement.

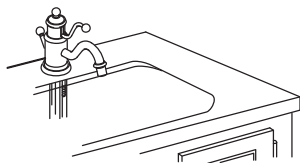

**NOTE:**

- For wooden countertop, use the clamp assembly supplied.
- For countertop made of wood or wood compound (over 25mm thick), purchase clamp assembly (94801000).
- For countertop of other materials, use proper clamp assembly by referring to the suggestions on the installation instructions of the countertop manufacturer.

- 在上紧夹具前，先将脸盆平整地放在盥洗台切口下，然后小心将脸盆拉起直至合度才可上夹具，切勿上得太紧。
- 立即擦去多余的密封胶。
- 最后将所有水管及水龙头与脸盆连接妥当 确保水管和龙头安装符合相关说明书要求。

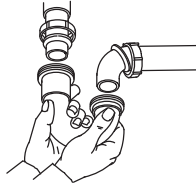

- Position the lavatory squarely under the cutout before tightening the clamps. Draw the lavatory rim up to the countertop until it is snug. **Do not overtighten.**
- Immediately wipe away any excess sealant.
- Make the final drain and faucet connection to complete the lavatory installation. Be sure to follow all instructions packed with the drain and faucet.
- Clean up with a **non-abrasive** cleaner.

- 使用非腐蚀性的清洁剂进行清洁。

### 用户须知 (护理和清洁)

为保持脸盆光洁如新，须确保每次使用后彻底冲洗干净，切勿使用腐蚀性的清洁剂，以免刮花及破坏脸盆的表面。要清除顽固污垢，油漆或柏油，可使用松油或油漆稀释剂。

不要在0°C以下的 环境中使用。

**警告：** 请勿使用钢丝球等硬质材料擦洗产品表面，特别是产品商标处。

### IMPORTANT CONSUMER INFORMATION(CARE AND CLEANING)

To keep your lavatory looking new, make sure you rinse it out thoroughly after each use. **DO NOT USE ABRASIVES** on this product, as they will scratch and ruin the surface. Stubborn stains, paint, or tar can be removed with turpentine or paint thinner.

Do not use the product below 0°C.

**CAUTION:** Please do not use hard materials (like scouring pad) to clean product surface, especially the product logo.

Basin mounting material  
安装组件  
94801000

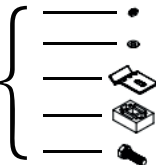

# 产品保修卡

产品型号		客户姓名	
销售单位		购买日期	
发票号码		客户电话	
经销商盖章		经销商电话	

感谢您购买本公司产品!为确保产品信誉及维护您的消费权益,自购买日起(以购买单据日期为准),本公司将为您提供免费的保修服务:陶瓷产品整机三年,官方服务平台注册成功后,延保二年,如产品用于商业用途整机保修一年,敬请放心使用。

按照说明书和使用注意事项正常使用后发生故障时,在保修期内免费维修。保修期内因故障要求维修时,可凭保修卡和原始发票与本公司联系,进行免费维修或更换(如果没有同样的型号则以类似型号代替,本公司保留此权利)。

如果超过保修期或遗失保修卡,本公司也提供维修服务并收取成本费用。

该有限责任仅适用于中国大陆(不包括香港、澳门、台湾)。

本公司产品的有限责任承担适合购买的本公司产品,保修期内以下情况下进行收费维修:

1. 因使用不当,误操作或者不正当的修理改造而造成的损坏。
2. 移动安装位置所造成的损坏。
3. 由火灾、地震、水灾、雷击、冰冻及其他自然灾害,公害和气体灾害、硫酸、盐酸、异常电压引起的损坏。
4. 用于一般家庭或者酒店以外的用途,所发生的损坏。
5. 因淤积的沙土、污物而产生的使用不良及包装等易耗品造成的损坏。

# Warranty Card

Model No.		Customer Name	
Seller		Purchasing Date	
Invoice No.		Customer Contact No.	
Distributor Stamp		Distributor Contact No.	

Thank you for purchasing our product! To maintain our product reputation and protect your consumer rights, we will provide you with three-years ( for the ceramic section ) free warranty service. After successful registration in the official platform the electric appliance will get an extended warranty of two years , if the product is for commercial use, the whole product will be warranted for a period of one year. please feel free to use .

where this product malfunctions when you use it normally according to the manual and precautions for use, it can be repaired free of charge during the warranty period. where this product needs to be repaired due to faults during the warranty period, you can contact our company with the warranty card and the original invoice for free repair or replacement ( it may be replaced with a similar model if the same model is not available, and we reserve this right ).

In the event of exceeding the warranty period or losing the warranty card, we also provide you with a repair service, which will be charged at cost.

This limited liability applies only to mainland China (excluding HongKong, Macau and Taiwan)

The under taking of the limited liability for the product of our company applies to our product purchased by you, and the repairs will be charged during the warranty period under the following conditions:

1. Damages caused by improper use, maloperation or improper repair or modification.
2. Damages caused by moving the installation location
3. Damages caused by fires, earthquakes, floods, lightning strikes, freezing and other natural disasters, public nuisances and gas disasters, sulfuric acid, hydrochloric acid, and abnormal voltage.
4. Damages caused by the uses other than the general household or hotel uses
5. Damages caused by improper uses incurred from silting-up sand and dirt and consumables such as packaging