

AXOR

DE / Gebrauchsanleitung / Montageanleitung	02
FR / Mode d'emploi / Instructions de montage	02
EN / Instructions for use / Assembly instructions	03
IT / Istruzioni per l'uso / Istruzioni per Installazione	03
ES / Modo de empleo / Instrucciones de montaje	04
NL / Gebruiksaanwijzing / Handleiding	04
DK / Brugsanvisning / Monteringsvejledning	05
PT / Instruções para uso / Manual de Instalação	05
PL / Instrukcja obsługi / Instrukcja montażu	06
CS / Návod k použití / Montážní návod	06
SK / Návod na použitie / Montážny návod	07
ZH / 用户手册 / 组装说明	07
RU / Руководство пользователя / Инструкция по монтажу	08
FI / Käyttöohje / Asennusohje	08
SV / Bruksanvisning / Monteringsanvisning	09
LT / Vartotojo instrukcija / Montavimo instrukcijos	09
HR / Upute za uporabu / Uputstva za instalaciju	10
RO / Manual de utilizare / Instrucțiuni de montare	10
EL / Οδηγίες χρήσης / Οδηγία συναρμολόγησης	11
SL / Navodilo za uporabo / Navodila za montažo	11
ET / Kasutusjuhend / Paigaldusjuhend	12
LV / Lietošanas pamācība / Montāžas instrukcija	12
SR / Uputstvo za upotrebu / Uputstvo za montažu	13
NO / Bruksanvisning / Montasjeveiledning	13
BG / Инструкция за употреба / Ръководство за монтаж	14
JP / 取扱説明書 / 施工説明書	14
SQ / Udhëzuesi i përdorimit / Udhëzime rreth montimit	15
AR / دليل الاستخدام / تعليمات التجميع	15
TR / Kullanım kılavuzu / Montaj kılavuzu	16
HU / Használati útmutató / Szerelési útmutató	17

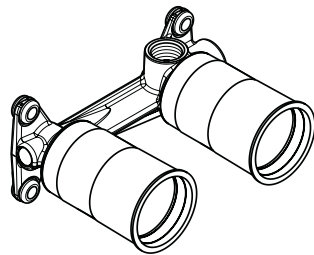

AXOR
13623180 / 13623187





⚠ SICHERHEITSHINWEISE

- ⚠ Bei der Montage müssen zur Vermeidung von Quetsch- und Schnittverletzungen Handschuhe getragen werden.
- ⚠ Große Druckunterschiede zwischen den Kalt- und Warmwasseranschlüssen müssen ausgeglichen werden.

MONTAGEHINWEISE

- / Vor der Montage muss das Produkt auf Transportschäden untersucht werden. Nach dem Einbau werden keine Transport- oder Oberflächenschäden anerkannt.
- / Die Leitungen und die Armatur müssen nach den gültigen Normen montiert, gespült und geprüft werden.
- / Die in den Ländern jeweils gültigen Installationsrichtlinien sind einzuhalten.

SYMBOLERKLÄRUNG

-  Kein essigsäurehaltiges Silikon verwenden!
-  FERTIGSET (siehe Seite 19)
-  MASSE (siehe Seite 31)
-  SERVICETEILE (siehe Seite 31)
-  PRÜFZEICHEN (siehe Seite 31)





⚠ CONSIGNES DE SÉCURITÉ

- ⚠ Lors du montage, porter des gants de protection pour éviter toute blessure par écrasement ou coupure.
- ⚠ Il est conseillé d'équilibrer les pressions de l'eau chaude et froide.

INSTRUCTIONS POUR LE MONTAGE

- / Avant son montage, s'assurer que le produit n'a subi aucun dommage pendant le transport. Après le montage, tout dommage de transport ou de surface ne pourra pas être reconnu.
- / Les conduites et la robinetterie doivent être montés, rincés et contrôlés selon les normes en vigueur.
- / Les directives d'installation en vigueur dans le pays concerné doivent être respectées.

DESCRIPTION DU SYMBOLE

-  Ne pas utiliser de silicone contenant de l'acide acétique!
-  SET DE FINITION (voir pages 19)
-  DIMENSIONS (voir pages 31)
-  PIÈCES DÉTACHÉES (voir pages 31)
-  CLASSIFICATION ACOUSTIQUE ET DÉBIT (voir pages 31)





△ SAFETY NOTES

- △ Gloves should be worn during installation to prevent crushing and cutting injuries.
- △ The hot and cold supplies must be of equal pressures.

INSTALLATION INSTRUCTIONS

- / Prior to installation, inspect the product for transport damages. After it has been installed, no transport or surface damage will be honoured.
- / The pipes and the fixture must be installed, flushed and tested as per the applicable standards.
- / The plumbing codes applicable in the respective countries must be observed.

SYMBOL DESCRIPTION

-  Do not use silicone containing acetic acid
-  FINISH SET (see page 19)
-  DIMENSIONS (see page 31)
-  SPARE PARTS (see page 31)
-  TEST CERTIFICATE (see page 31)





△ INDICAZIONI SULLA SICUREZZA

- △ Durante il montaggio, per evitare ferite da schiacciamento e da taglio bisogna indossare guanti protettivi.
- △ Attenzione! Compensare le differenze di pressione tra i collegamenti dell'acqua fredda e dell'acqua calda.

ISTRUZIONI PER IL MONTAGGIO

- / Prima del montaggio è necessario controllare che non ci siano stati danni durante il trasporto. Una volta eseguito il montaggio, non verranno riconosciuti eventuali danni di trasporto o delle superfici.
- / Montare, lavare e controllare tubature e rubinetteria rispettando le norme correnti.
- / Vanno rispettate le direttive di installazione nazionali vigenti nel rispettivo paese.

DESCRIZIONE SIMBOLO

-  Non utilizzare silicone contenente acido acetico!
-  SET ESTERNO (vedi pagg. 19)
-  INGOMBRI (vedi pagg. 31)
-  PARTI DI RICAMBIO (vedi pagg. 31)
-  SEGNO DI VERIFICA (vedi pagg. 31)



△ INDICACIONES DE SEGURIDAD

- △ Durante el montaje deben utilizarse guantes para evitar heridas por aplastamiento o corte.
- △ Grandes diferencias de presión en servicio entre agua fría y agua caliente deben equilibrarse.

INDICACIONES PARA EL MONTAJE

- / Antes del montaje se debe examinar el producto contra daños de transporte. Después de la instalación no se reconoce ningún daño de transporte o de superficie.
- / Los conductos y la grifería deben montarse, lavarse y comprobarse según las normas vigentes.
- / Es obligatorio el cumplimiento de las directrices de instalación vigentes en el país respectivo.

DESCRIPCIÓN DE SÍMBOLOS

No utilizar silicona que contiene ácido acético!



EMBELLECEDOR EXTERIOR
(ver página 19)



DIMENSIONES (ver página 31)



REPUESTOS (ver página 31)



MARCA DE VERIFICACIÓN
(ver página 31)

△ VEILIGHEIDSINSTRUCTIES

- △ Bij de montage moeten ter voorkoming van knel- en snijwonden handschoenen worden gedragen.
- △ Grote drukverschillen tussen de koud- en warmwater-toevoer dienen vermeden te worden.

MONTAGE-INSTRUCTIES

- / Vóór de montage moet het product gecontroleerd worden op transportschade. Na de inbouw wordt geen transport- of oppervlakteschade meer aanvaard.
- / De leidingen en armaturen moeten gemonteerd, gespoeld en gecontroleerd worden volgens de geldige normen.
- / De in de overeenkomstige landen geldende installatie-richtlijnen moeten nageleefd worden.

SYMBOOLBESCHRIJVING

Gebruik geen zuurhoudende siliconen!



KLEURSET (zie blz. 19)



MATEN (zie blz. 31)



SERVICE ONDERDELEN
(zie blz. 31)



KEURMERK (zie blz. 31)







△ SIKKERHEDSANVISNINGER

- △ Ved monteringen skal der bruges handsker for at undgå kvæstelser og snitsår.
- △ Større trykforskelle mellem koldt og varmt vand bør udjævnes.

MONTERINGSANVISNINGER

- / Før monteringen skal produktet kontrolleres for transportskader. Efter monteringen godkendes transportskader eller skader på overfladen ikke længere.
- / Ledningerne og armaturerne skal monteres, skylles og kontrolleres iht. de gældende standarder.
- / Installationsbestemmelserne, der gælder i det enkelte land, skal overholdes.

SYMBOLBESKRIVELSE

-  Der må ikke benyttes eddikesyreholdig silikone!
-  KAPPESÆT (se s. 19)
-  MÅLENE (se s. 31)
-  RESERVEDELE (se s. 31)
-  GODKENDELSE (se s. 31)







△ AVISOS DE SEGURANÇA

- △ Durante a montagem devem ser utilizadas luvas de protecção, de modo a evitar ferimentos resultantes de entalamentos e de cortes.
- △ Grandes diferenças entre as pressões das águas quente e fria devem ser compensadas.

AVISOS DE MONTAGEM

- / Antes da montagem deve-se controlar o produto relativamente a danos de transporte. Após a montagem não são aceites quaisquer danos de transporte ou de superfície.
- / As tubagens e a torneira têm que ser montadas, enxaguadas e verificadas de acordo com as normas em vigor.
- / A prescrições de instalação válidas nos respetivos países devem ser respeitadas.

DESCRIÇÃO DO SÍMBOLO

-  Não utilizar silicone que contenha ácido acético!
-  CONJUNTO COMPLETO (ver página 19)
-  MEDIDAS (ver página 31)
-  PEÇAS DE SUBSTITUIÇÃO (ver página 31)
-  MARCA DE CONTROLO (ver página 31)



Δ WSKAZÓWKI BEZPIECZEŃSTWA

- Δ Aby uniknąć zranień na skutek zgniecenia lub przecięcia, podczas montażu należy nosić rękawice ochronne.
- Δ Znaczne różnice ciśnień na dopływach ciepłej i zimnej wody muszą zostać wyrównane.

WSKAZÓWKI MONTAŻOWE

- / Przed montażem należy skontrolować produkt pod kątem szkód transportowych. Po montażu nie widać żadnych szkód transportowych ani szkód na powierzchni.
- / Przewody i armatura muszą być montowane, płukane i kontrolowane według obowiązujących norm.
- / Należy przestrzegać wytycznych instalacyjnych obowiązujących w danym kraju.

OPIS SYMBOLU



Nie stosować silikonów zawierających kwas octowy!



ELEMENTY ZEWNĘTRZNE (patrz strona 19)



WYMIARY (patrz strona 31)



CZĘŚCI SERWISOWE (patrz strona 31)



ZNAK JAKOŚCI (patrz strona 31)

Δ BEZPEČNOSTNÍ POKYNY

- Δ Pro zabránění řezným zraněním a pohmožděninám je nutné při montáži nosit rukavice.
- Δ Je nutné vyrovnat velké rozdíly tlaku mezi přípoji studené a teplé vody.

POKYNY K MONTÁŽI

- / Před montáží je třeba produkt zkontrolovat, zda nebyl při transportu poškozen. Po zabudování nebudou uznány žádné škody způsobené transportem nebo poškození povrchu.
- / Vedení a armatura musí být namontovány, propláchnuty a otestovány podle platných norem.
- / Je třeba dodržovat montážní pravidla platná v dané zemi.

POPIS SYMBOLŮ



Nepoužívat silikon s obsahem kyseliny octové!



VRCHNÍ SADA (viz strana 19)



ROZMĚRY (viz strana 31)



SERVISNÍ DÍLY (viz strana 31)



ZKUŠEBNÍ ZNAČKA (viz strana 31)







△ BEZPEČNOSTNÉ POKYNY

- △ Pri montáži musíte nosiť rukavice, aby ste predišli pomliaždeninám a rezným poraneniam.
- △ Veľké rozdiely v tlaku medzi prípojkami studenej a teplej vody musia byť vyrovnané.

POKYNY PRE MONTÁŽ

- / Pred montážou musíte produkt skontrolovať, či nebol počas transportu poškodený. Po zabudovaní nebudú uznané žiadne škody spôsobené transportom alebo poškodenia povrchu.
- / Potrubia a vybavenie musia byť namontované, prepláchnuté a vybavené v platnom normami.
- / Je potrebné dodržiavať smernice o inštalácii, ktoré sú práve teraz platné v krajinách.

POPIS SYMBOLOV

-  Nepoužívať silikón s obsahom kyseliny octovej!
-  VRCHNÁ SADA (viď strana 19)
-  ROZMERY (viď strana 31)
-  SERVISNÉ DIELY (viď strana 31)
-  OSVEDČENIE O SKÚŠKE (viď strana 31)





△ 安全技巧

- △ 装配时为避免挤压和切割受伤，必须戴上手套。
- △ 冷热水管间过大的压力差必须予以平衡。

安装提示

- / 安装前必须检查产品是否受到运输损害。安装后将不认可运输损害或表面损伤。
- / 管道和阀门必须根据通用标准进行安装、冲洗和检查。
- / 请遵守当地国家现行的安装规定。

符号说明

-  请勿使用含有乙酸的硅胶！
-  加工件 (参见第页 19)
-  大小 (参见第页 31)
-  备用零件 (参见第页 31)
-  检验标记 (参见第页 31)



УКАЗАНИЯ ПО ТЕХНИКЕ БЕЗОПАСНОСТИ

- ⚠ Во время монтажа следует надеть перчатки во избежание прищемления и порезов.
- ⚠ донного клапа. Перед установкой смесителя необходимо регулировочными кранами выровнять давление холодной и горячей воды при помощи вентилей регулирующих подачу воды в квартиру.

УКАЗАНИЯ ПО МОНТАЖУ

- / Перед монтажом следует проверить изделие на предмет повреждений при перевозке. После монтажа претензии о возмещении ущерба за повреждения при перевозке или повреждения поверхностей не принимаются.
- / Трубы и арматура должны быть установлены, промыты и проверены в соответствии с действующими нормами.
- / Необходимо соблюдать требования по монтажу, действующие в соответствующих странах.

ОПИСАНИЕ СИМВОЛОВ



Не применяйте силикон, содержащий уксусную кислоту.



НАРУЖНАЯ ЧАСТЬ (см. стр. 19)



РАЗМЕРЫ (см. стр. 31)



КОМПЛЕКТ (см. стр. 31)



ЗНАК ТЕХНИЧЕСКОГО КОНТРОЛЯ (см. стр. 31)

TURVALLISUUSOHJEET

- ⚠ Asennuksessa on käytettävä käsiineitä puristumien ja viiltojen aiheuttamien tapaturmien estämiseksi.
- ⚠ Suuret paine-erot kylmä- ja kuumavesiliitännöjen välillä on tasattava.

ASENNUSOHJEET

- / Ennen asennusta on tarkastettava tuotteen mahdolliset kuljetusvahingot. Asennuksen jälkeen kuljetus- ja pintavaurioita ei hyväksytä.
- / Putket ja hana on asennettava, huuhdeltava ja tarkastettava voimassa olevien standardien mukaisesti.
- / Jokaisessa maassa on noudatettava siellä päteviä asennusohjeita.

MERKIN KUVAUS



Älä käytä etikkahappopitoista silikonial



VALMISSARJA (katso sivu 19)



MITAT (katso sivu 31)



VARAOSAT (katso sivu 31)



KOESTUSMERKKI (katso sivu 31)







△ SÄKERHETSANVISNINGAR

- △ Handskar ska bäras under monteringsarbetet så att man kan undvika kläm- och skärskador.
- △ Stora tryckskillnader mellan anslutningarna för varmt och kallt vatten måste utjämnas.

MONTERINGSANVISNINGAR

- / Det måste undersökas om produkten har transportskador innan den monteras. Efter monteringen accepteras inga transport- eller ytskiktskador.
- / Ledningarna och blandaren måste monteras, spolas igenom och kontrolleras enligt de gällande normerna.
- / De installationsriktlinjer som gäller i länderna ska följas.

SYMBOLFÖRKLARING

-  Använd inte silikon som innehåller ättiksyra!
-  FÄRDIGSET (se sidan 19)
-  MÅTTEN (se sidan 31)
-  RESERVDELAR (se sidan 31)
-  TESTSIGILL (se sidan 31)





△ SAUGUMO TECHNIKOS NURODYMAI

- △ Apsaugai nuo užspaudimo ir įsijavimo montavimo metu mūvėkite pirštines.
- △ Turi būti išlyginti šalto ir karšto slėgio nelygumai.

MONTAVIMO INSTRUKCIJA

- / Prieš montuojant būtina patikrinti, ar gaminyje nebuvo pažeistas transportavimo metu. Sumontavus pretenzijos dėl transportavimo ir paviršiaus pažeidimų nepriimamos.
- / Vamzdžiai ir sujungimai turi būti montuojami, plaunami ir tikrinami pagal galiojančias normas.
- / Laikykites atitinkamoje šalyje galiojančių direktyvų dėl įrengimo.

SIMBOLIO APRĄŠYMAS

-  Nenaudokite silikono, kurio sudėtyje yra acto rūgšties!
-  VIRŠTINKINĖ (žr. psl. 19)
-  IŠMATAVIMAI (žr. psl. 31)
-  ATSARGINĖS DALYS (žr. psl. 31)
-  BANDYMO PAŽYMA (žr. psl. 31)







⚠ SIGURNOSNE UPUTE

- ⚠ Prilikom montaže se radi sprječavanja prignječenja i posjekotina moraju nositi rukavice.
- ⚠ Velika razlika u pritisku između vruće i hladne vode mora biti izbalansirana.

UPUTE ZA MONTAŽU

- / Prije montaže mora se provjeriti je li proizvod oštećen prilikom transporta. Nakon ugradnje se ne priznaju nikakve reklamacije koje se odnose na površinska i transportna oštećenja.
- / Cijevi i armatura moraju biti postavljeni, isprani i testirani prema važećim normama.
- / Obvezno se moraju uvažiti propisi o instalacijama koji vrijede u dotičnoj zemlji.

OPIS SIMBOLA

-  Nemojte koristiti silikon koji sadrži octenu kiselinu!
-  ZAVRŠNI SET (pogledaj stranicu 19)
-  MJERE (pogledaj stranicu 31)
-  REZERVNI DJELOVI (pogledaj stranicu 31)
-  OZNAKA TESTIRANJA (pogledaj stranicu 31)





⚠ INSTRUCȚIUNI DE SIGURANȚĂ

- ⚠ La montare utilizați mănuși pentru evitarea contuziunilor și tăierii mâinilor.
- ⚠ Diferențele de presiune mari între alimentarea cu apă rece și apă caldă trebuie echilibrate.

INSTRUCȚIUNI DE MONTARE

- / Înainte de instalare verificați, dacă produsul prezintă deteriorări de transport. După instalare garanția nu acoperă deteriorările de transport și cele de suprafață.
- / Conductele și bateriile trebuie montate, spălate și verificate conform normelor în vigoare.
- / Respectați reglementările referitoare la instalare valabile în țara respectivă.

DESCRIEREA SIMBOLURILOR

-  Nu utilizați silikon cu conținut de acid acetic!
-  SET COMPLET (vezi pag. 19)
-  DIMENSIUNI (vezi pag. 31)
-  PIESE DE SCHIMB (vezi pag. 31)
-  CERTIFICAT DE TESTARE (vezi pag. 31)





⚠ ΥΠΟΔΕΙΞΕΙΣ ΑΣΦΑΛΕΙΑΣ

- ⚠ Για να αποφύγετε τραυματισμούς κατά τη συναρμολόγηση πρέπει να φοράτε γάντια.
- ⚠ Οι διαφορές της πίεσης μεταξύ της σύνδεσης κρύου και ζεστού νερού θα πρέπει να αντισταθμίζονται.

ΟΔΗΓΙΕΣ ΣΥΝΑΡΜΟΛΟΓΗΣΗΣ

- / Πριν τη συναρμολόγηση πρέπει να εξεταστεί το προϊόν για ζημιές μεταφοράς. Μετά την εγκατάσταση δεν αναγνωρίζονται ζημιές από τη μεταφορά ή επιφανειακές ζημιές.
- / Οι σβλήνες και η μπαταρία πρέπει να τοποθετηθούν σύμφωνα με τα ισχύοντα πρότυπα, να τεθούν υπό πίεση και να δοκιμαστούν.
- / Θα πρέπει να τηρούνται οι οδηγίες εγκατάστασης που ισχύουν σε κάθε κράτος.

ΠΕΡΙΓΡΑΦΗ ΣΥΜΒΟΛΩΝ

-  Μην χρησιμοποιείτε σιλικόνη που περιέχει οξικό οξύ!
-  ΣΕΤ ΜΗΧΑΝΙΣΜΟΥ (βλ. Σελίδα 19)
-  ΔΙΑΣΤΑΣΕΙΣ (βλ. Σελίδα 31)
-  ΑΝΤΑΛΛΑΚΤΙΚΑ (βλ. Σελίδα 31)
-  ΣΗΜΑ ΕΛΕΓΧΟΥ (βλ. Σελίδα 31)





⚠ VARNOSTNA OPOZORILA

- ⚠ Pri montaži je treba nositi rokavice, da se preprečijo poškodbe zaradi zmečkanja ali urezov.
- ⚠ Velike razlike v tlaku med priključkom za mrzlo in priključkom za toplo vodo je potrebno izravnati.

NAVODILA ZA MONTAŽO

- / Pred montažo je treba izdelek preveriti glede morebitnih transportnih poškodb. Po vgradnji transportne ali površinske poškodbe ne bodo več priznane.
- / Cevi in armaturo je treba montirati, izprati in preveriti po veljavnih standardih.
- / Upoštevati je treba pravilnike o inštalacijah, ki veljajo v posamezni državi.

OPIS SIMBOLA

-  Ne smete uporabiti silikona, ki vsebuje ocatno kislino!
-  ZAKLJUČNA GARNITURA (glejte stran 19)
-  MERE (glejte stran 31)
-  REZERVNI DELI (glejte stran 31)
-  PRESKUSNI ZNAK (glejte stran 31)







△ OHUTUSJUHISED

- △ Kandke paigaldamisel muljumis- ja löihevigastuste vältimiseks kindaid.
- △ Kui külma ja kuuma vee ühenduste surve on väga erinev, tuleb need tasakaalustada.

PAIGALDAMISJUHISED

- / Enne paigaldamist tuleb toodet kontrollida transpordikahjustuste osas. Pärast paigaldamist ei tunnustata enam transpordi- või pinnakahjustuste kaebuseid.
- / Voolikute ja segisti paigaldamisel, loputamisel ja kontrollimisel tuleb lähtuda kehtivatest normatiividest.
- / Vastavas riigis kehtivaid paigalduseeskirju tuleb järgida.

SÜMBOLITE KIRJELDUS

-  Ärge kasutage äädikhapet sisaldavat silikooni!
-  VALMISKOMPLEKT (vt lk 19)
-  MÕÕTUDE (vt lk 31)
-  VARUOSAD (vt lk 31)
-  KONTROLLSERTIFIKAAT (vt lk 31)





△ DROŠĪBAS NORĀDES

- △ Montāžas laikā, lai izvairītos no saspiedumiem un iegriezumiem, nepieciešams nēsāt cimdus.
- △ Jāizlīdzina spiediena atšķirības starp aukstā un karstā ūdens pievadiem.

NORĀDĪJUMI MONTĀŽAI

- / Pirms montāžas nepieciešams pārbaudīt, vai produktam transportēšanas laikā nav radušies bojājumi. Pēc iebūvēšanas bojājumi, kas radušies transportēšanas laikā, vai virsmas bojājumi netiek atzīti.
- / Cauruļvadi un armatūra ir jāuzstāda, jāizskalo un jāpārbauda saskaņā ar spēkā esošajiem standartiem.
- / Jāievēro attiecīgās valstis spēkā esošās montāžas prasības.

SIMBOLU NOZĪME

-  Neizmantojiet silikonu, kas satur etiķskābi!
-  KOMPLEKTS (skat. lpp. 19)
-  IZMĒRUS (skat. lpp. 31)
-  REZERVES DAĻAS (skat. lpp. 31)
-  PĀRBAUDES ZĪME (skat. lpp. 31)







△ SIGURNOSNE NAPOMENE

- △ Prilikom montaže se radi sprečavanja prignječenja i posekotina moraju nositi rukavice.
- △ Velika razlika u pritisku između vruće i hladne vode mora biti izbalansirana.

INSTRUKCIJE ZA MONTAŽU

- / Pre montaže se mora proveriti da li je proizvod oštećen pri transportu. Nakon ugradnje se ne priznaju nikakve reklamacije koje se odnose na površinska i transportna oštećenja.
- / Vodovi i armatura moraju biti postavljeni, isprani i testirani prema važećim normama.
- / Treba se pridržavati propisa koji u određenim zemljama važe za instalacije.

OPIS SIMBOLA

-  Nemojte koristiti silikon koji sadrži sirćetnu kiselinu!
-  ZAVRŠNI SET (vidi stranu 19)
-  MERE (vidi stranu 31)
-  REZERVNI DELOVI (vidi stranu 31)
-  ISPITNI ZNAK (vidi stranu 31)





△ SIKKERHETSHENVISNINGER

- △ Bruk hansker under montasjen for å unngå klem- og kuttskader.
- △ Store trykkdifferanser mellom kaldt- og varmtvannstilkoblinger skal utlignes.

MONTAGEHENVISNINGER

- / Før montasjen skal produktet sjekkes for transportskader. Etter monteringen aksepteres ikke noen transport- eller overflateskader.
- / Ledningene og armaturen skal monteres, spyles og sjekkes iht. de gyldige normer.
- / Gjeldende retningslinjer for rørleggerarbeid i de enkelte land skal følges.

SYMBOLBESKRIVELSE

-  Ikke bruk silikon som inneholder eddiksyre!
-  FERDIGSETT (se side 19)
-  MÅL (se side 31)
-  SERVICEDELER (se side 31)
-  PRØVEMERKE (se side 31)

△ УКАЗАНИЯ ЗА БЕЗОПАСНОСТ

- △ При монтажа трябва да се носят ръкавици, за да се избегнат наранявания поради притискане или порязване.
- △ Големите разлики в налягането между изводите за студената и топлата вода трябва да се изравняват.

УКАЗАНИЯ ЗА МОНТАЖ

- / Преди монтажа продуктът трябва да се провери за транспортни щети. След монтажа не се признават транспортни или повърхностни щети.
- / Тръбопроводите и арматурата трябва да се монтират, промият и проверят в съответствие с валидните норми.
- / Трябва да бъдат спазвани валидните в съответните страни предписания за инсталиране.

ОПИСАНИЕ НА СИМВОЛИТЕ



Не използвайте силикон, съдържащ оцетна киселина!



ГОТОВ НАБОР (вижте стр. 19)



РАЗМЕРИ (вижте стр. 31)



СЕРВИЗНИ ЧАСТИ (вижте стр. 31)



КОНТРОЛЕН ЗНАК (вижте стр. 31)

△ 安全上の注意

- △ 施工の際は手を挟んだり怪我をしないように、手袋をはめてください。
- △ 給水・湯の圧力差は0.1(MPa)以内としてください。

施工上の注意

- / 製品の施工前に輸送でのダメージがないか確認してください。施工後のキズ等のお申し出はお断りさせていただきます。
- / 配管と水栓は、関連法規に従って施工、洗浄、および試験を行ってください。
- / 施工行う地域に適用される関連法規をお守りください。

アイコンの説明



酢酸系シリコンをご使用にならないでください!



化粧部 (次のページを参照 19)



寸法 (次のページを参照 31)



スペアパーツ (次のページを参照 31)



認証について (次のページを参照 31)



△ UDHËZIME SIGURIE

- △ Për të evituar lëndimet e pickimeve ose të prerjeve gjatë procesit të montimit duhet që të vishni doreza.
- △ Ndryshimet e mëdha të presionit mes lidhjeve të ujit të ftohtë dhe atij të ngrohtë duhen ekuilibruar.

UDHËZIME PËR MONTIMIN

- / Përpara montimit duhet që produkti të kontrollohet për dëmtime nga transporti. Pas instalimit nuk do të njihet asnjë dëmtim nga transporti ose dëmtim i sipërfaqes.
- / Tubacionet dhe rubinetet duhet që të montohen, të shpëlohen dhe të kontrollohen sipas standardeve në fuqi
- / Duhet të respektohen linjat udhëzuese të instalimit, të vlefshme për vendet respektive.

PËRSHKRIMI I SIMBOLIT



Mos përdorni silikon që në përbërje ka acid acetik.



KOMPLET I GATSHËM (shih faqen 19)



PËRMASAT (shih faqen 31)



PJESËT E SERVISIT (shih faqen 31)



SHENJA E KONTROLLIT (shih faqen 31)

△ تنبيهات الأمان

- △ يجب ارتداء قفازات لليد أثناء التركيب لتجنب حدوث أضرار الإنحشار أو الجروح
- △ يجب أن يكون تيار الماء الساخن والماء البارد متعادلين في الضغط.

تعليمات التركيب

- / قبل القيام بعملية التركيب، يجب فحص المنتج للتأكد من خلوّه من أية تلفيات ناتجة عن النقل بعد القيام بعملية التركيب، لن يتم الاعتراف بوجود أية تلفيات سطحية أو تلفيات ناتجة عن عملية النقل.
- / يجب تركيب وغسيل واختبار التوصيلات وخلطات المياه طبقاً للمعايير السارية.
- / يجب مراعاة القواعد الخاصة بالتركيب وأعمال السباكة وفقاً للوائح الخاصة بكل بلد.

وصف الرمز

هام! لا تستخدم السليكون الذي يحتوي على أحماض!



مجموعة كاملة. (راجع صفحة 19)



أبعاد (راجع صفحة 31)



قطع الغيار (راجع صفحة 31)



شهادة اختبار (راجع صفحة 31)



△ GÜVENLİK UYARILARI

- △ Montaj esnasında ezilme ve kesilme gibi yaralanmaları önlemek için eldiven kullanılmalıdır.
- △ Sıcak ve soğuk su bağlantıları arasında büyük basınç farklılıkları varsa, bu basınç farklılıklarının dengelenmesi gerekir.

MONTAJ AÇIKLAMALARI

- / Montaj işleminden önce ürün nakliye hasarları yönünden kontrol edilmelidir. Montaj işleminden sonra nakliye veya yüzey hasarları için sorumluluk üstlenilmemektedir.
- / Boruların ve armatürün montajı, yıkanması ve kontrolü geçerli normlara göre yapılmalıdır.
- / Ülkelerde geçerli kurulum yönetmeliklerine riayet edilmelidir.

SİMGE AÇIKLAMASI

Asetik asit içeren silikon kullanmayın!



DIŞI SET (bakınız sayfa 19)



ÖLÇÜLERİ (bakınız sayfa 31)



YEDEK PARÇALAR (bakınız sayfa 31)



KONTROL İŞARETİ
(bakınız sayfa 31)

GARANTİ BELGESİ**ÜRETİCİ VEYA İTHALATÇI FİRMANIN**

Unvanı: Hansgrohe Armatür Ltd. Şti
Adresi: Fulya Mahallesi Bahçeler Sokak Efe han 20/C
Mecidiyeköy Şişli İstanbul
Telefonu: (0-212) 273 07 30
Faks: (0-212) 273 07 40
web adresi: www.hansgrohe.com.tr

MALİN

Markası: Hansgrohe
Cinsi: Sıhhi tesisat malzemesi
Garanti Süresi: 2 YIL
Azami Tamir Süresi: 20 İş günü

**GENEL MÜDÜR
ALBERT EMLEK**

Satıcı Firmanın:

Unvanı:
Adresi:
Telefonu:
Faks:
e-posta:
Fatura Tarih ve Sayısı:
Marka ve Modeli:
Teslim Tarihi ve Yeri:
Yetkilinin İmzası:
Firmanın Kaşesi:

**BU BÖLÜMÜ, ÜRÜNÜ ALDIĞINIZ
YETKİLİ SATICI İMZALAYACAK VE
KAŞELEYECEKTİR.**



△ BIZTONSÁGI UTASÍTÁSOK

- △ A szerelésnél a zúzódások és vágási sérülések elkerülése érdekében kesztyűt kell viselni.
- △ A hidegvíz- és a melegvíz-csatlakozások közötti nagy nyomáskülönbséget kikell egyenlíteni!

SZERELÉSI UTASÍTÁSOK

- / A szerelés előtt ellenőrizni kell, hogy a terméknek nincs-e szállítási sérülése. Beépítés után a szállítási- vagy felületi sérüléseket nem ismerik el.
- / A vezetékeket és a csaptelepet az érvényes szabványoknak megfelelően kell felszerelni, öblíteni és ellenőrizni
- / Az egyes országokban érvényes installációs irányelveket be kell tartani.

SZIMBÓLUMOK LEÍRÁSA



Ne használjon ecetsavtartalmú szilikont!



A KÉSZ SZERELVÉNY
(lásd a oldalon 19)



MÉRETET (lásd a oldalon 31)



TARTOZÉKOK (lásd a oldalon 31)



VIZSGAJEL (lásd a oldalon 31)



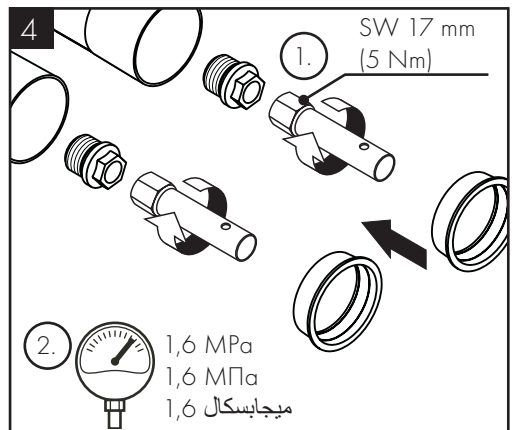
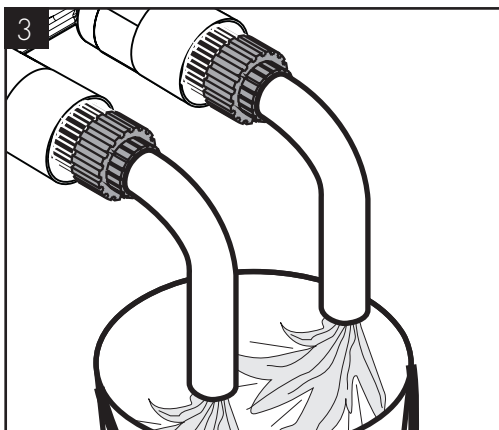
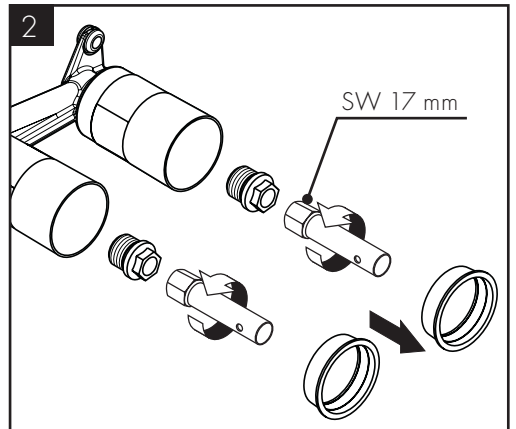
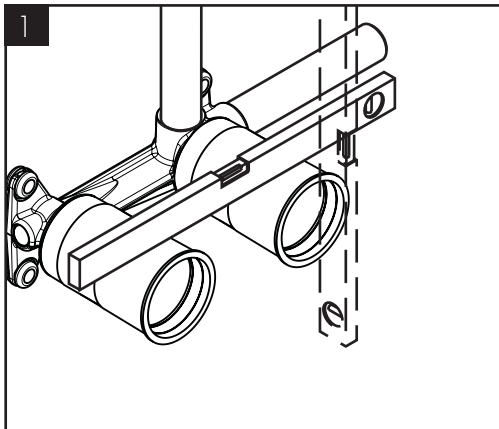
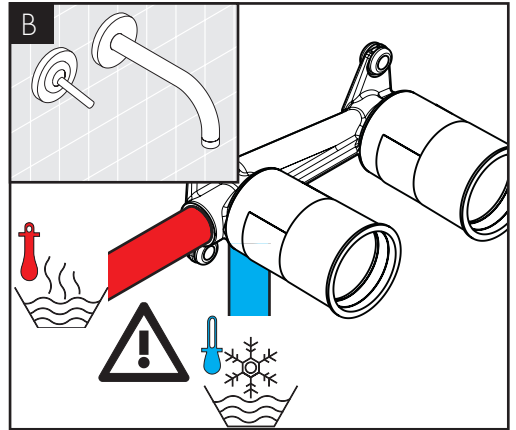
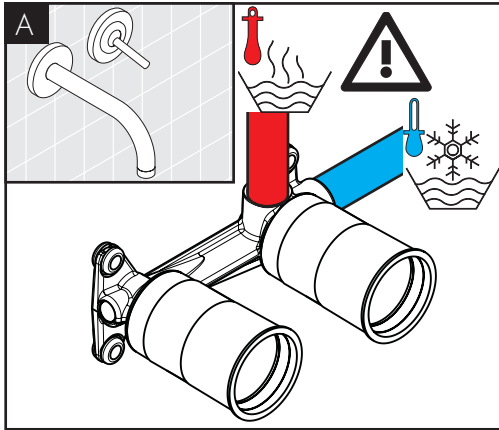



AXOR Citterio M
34112XXX / 34115XXX

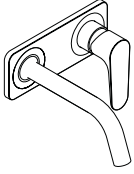

AXOR Citterio M
34113XXX / 34116XXX

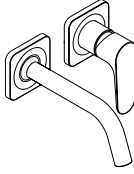

UNO
38112XXX / 38115XXX

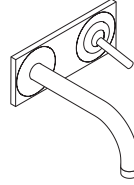

AXOR Uno
38113XXX / 38116XXX

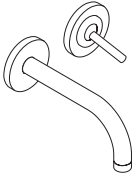

AXOR Uno
38121XXX / 38122XXX



AXOR Citterio
39112XXX / 39115XXX

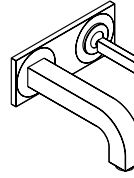

AXOR Citterio
39113XXX / 39116XXX

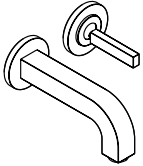

AXOR One
48120XXX



AXOR Uno
45112XXX / 45113XXX

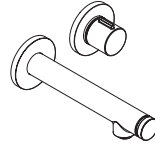

AXOR Citterio E
36106XXX

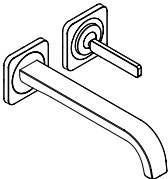

AXOR Citterio E
36114XXX

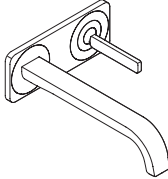

AXORUno
38815XXX

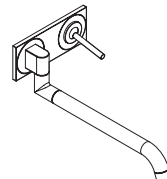



AXOR Citterio M
34112XXX

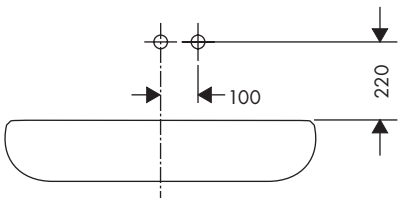
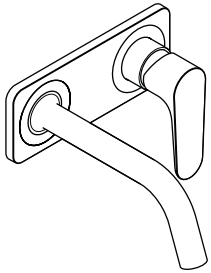
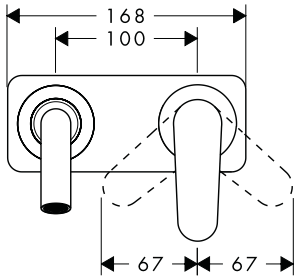
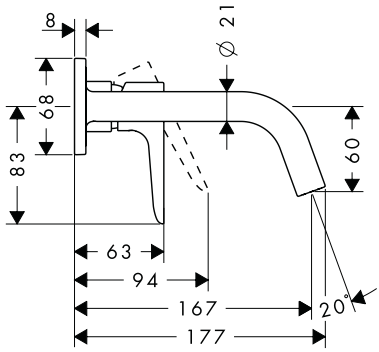

AXOR Citterio M
34115XXX

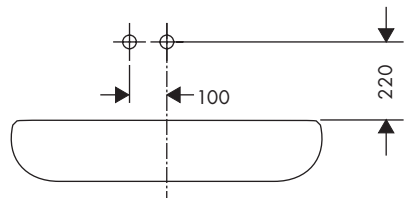
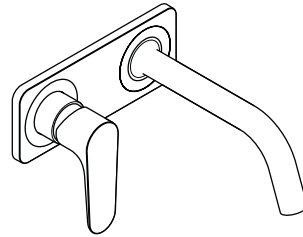
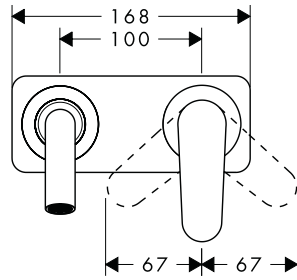
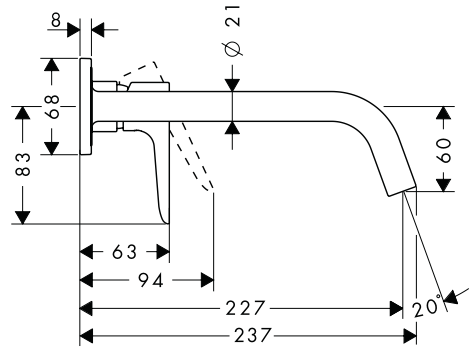



AXOR Citterio M
34113XXX

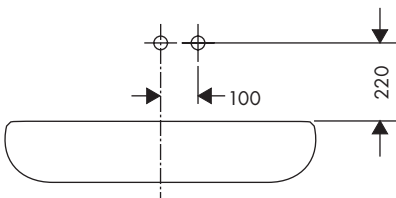
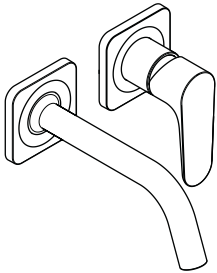
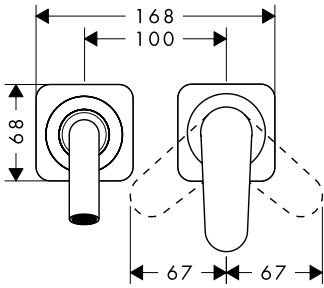
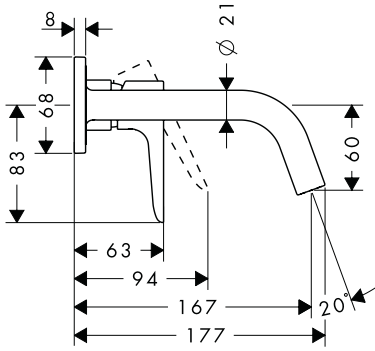

AXOR Citterio M
34116XXX

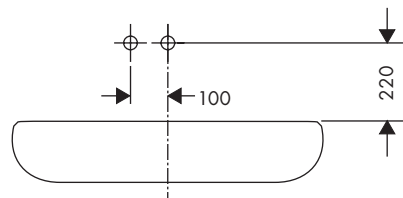
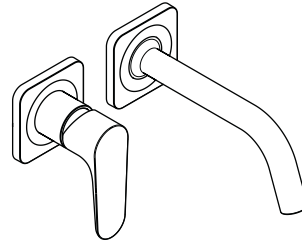
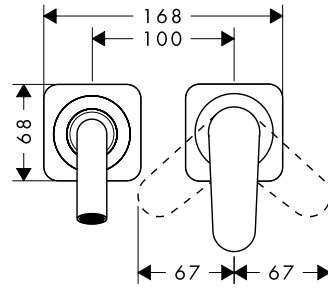
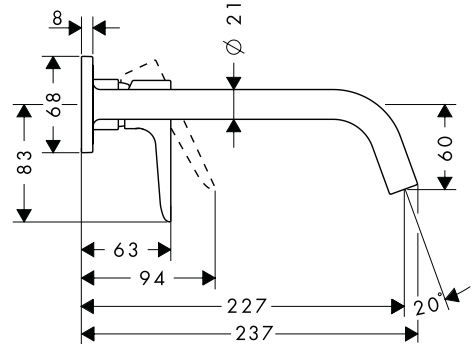



UNO
38112XXX

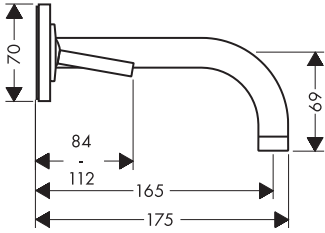

UNO
38115XXX

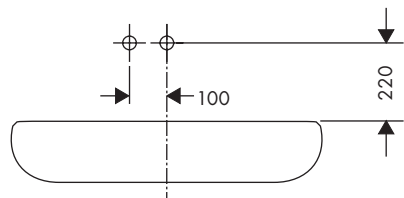
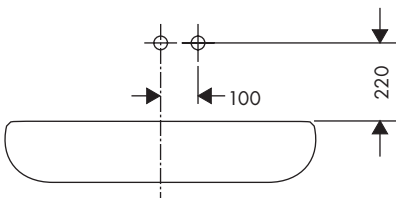
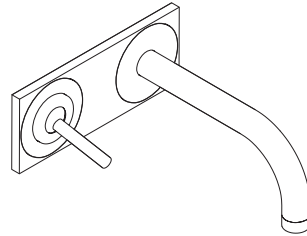
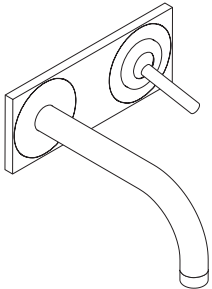
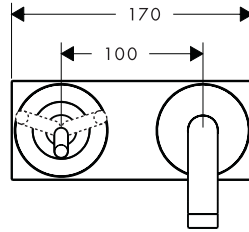
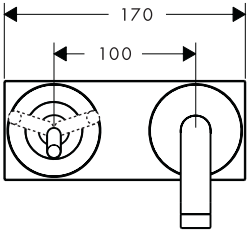
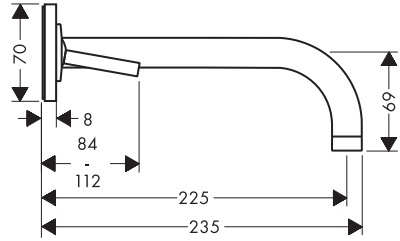



AXOR Uno
38113XXX

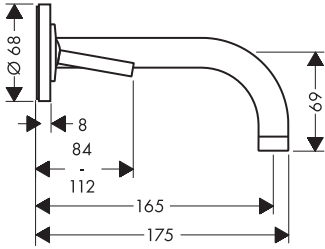

AXOR Uno
38116XXX

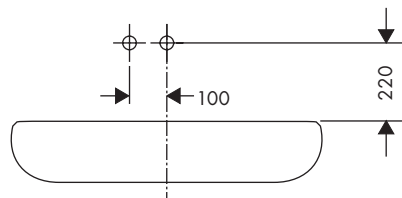
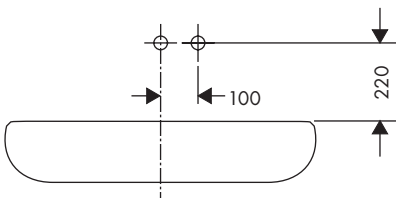
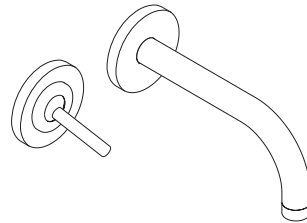
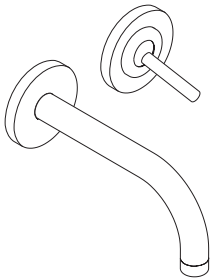
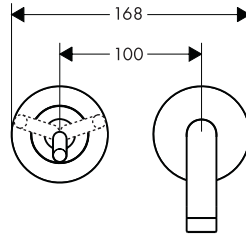
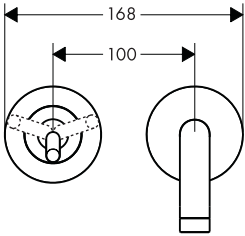
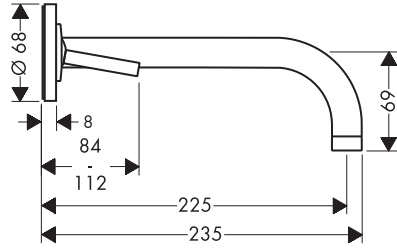



AXOR Uno
38121XXX

AXOR Uno
38122XXX

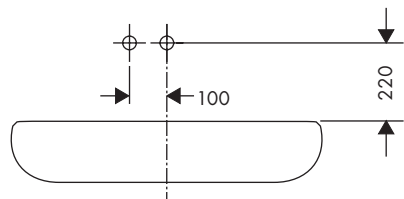
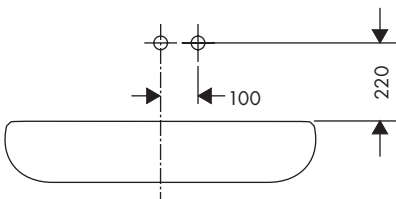
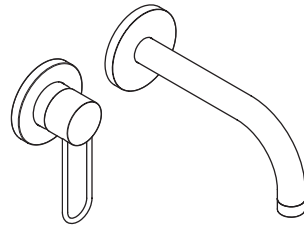
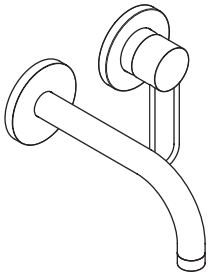
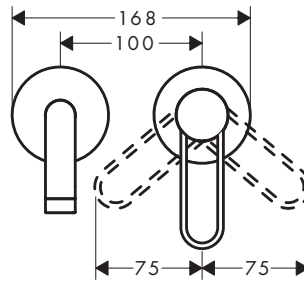
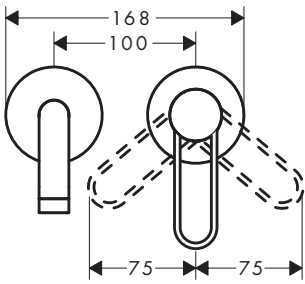
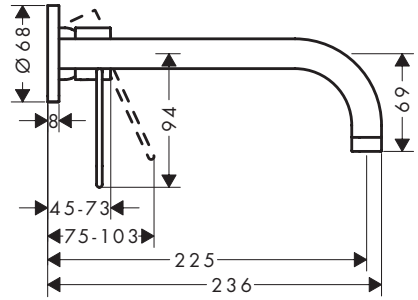
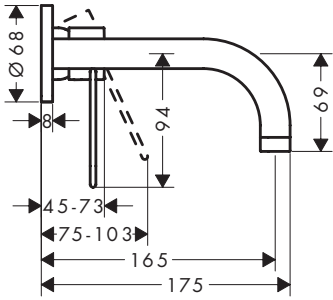



AXOR Citterio
39112XXX

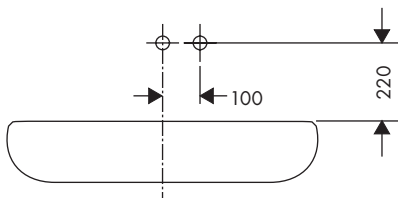
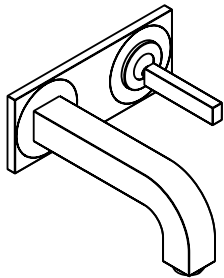
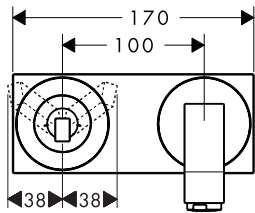
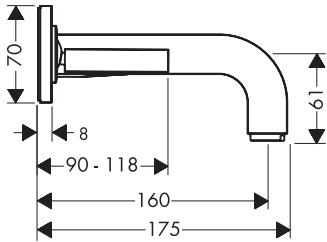

AXOR Citterio
39115XXX

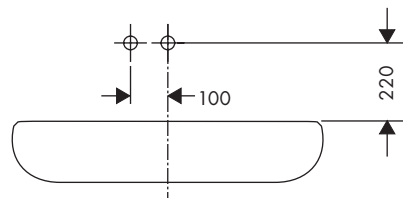
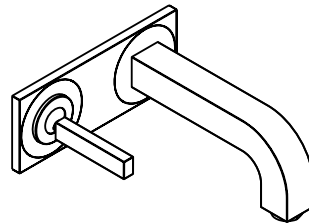
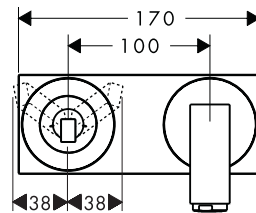
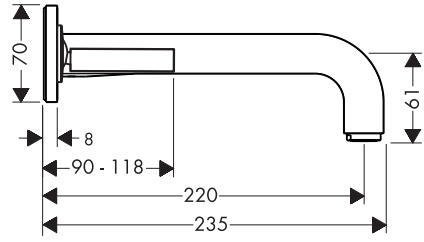



AXOR Citterio
39113XXX

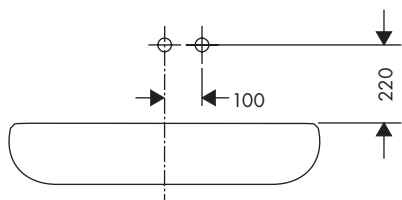
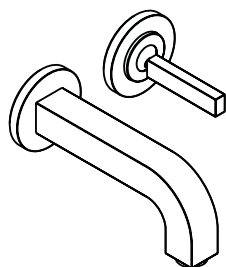
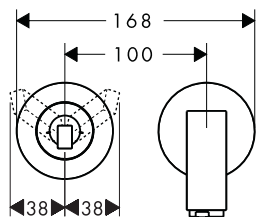
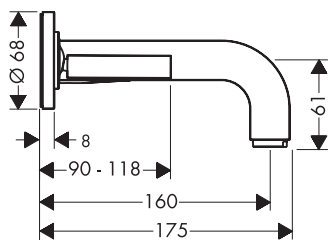

AXOR Citterio
39116XXX

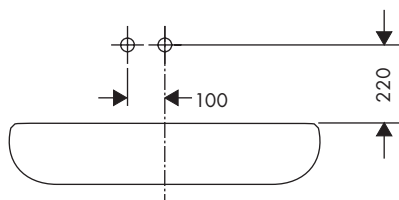
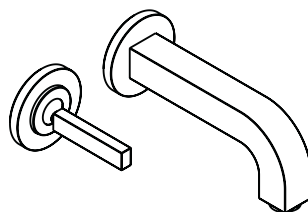
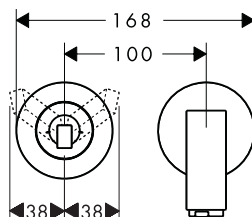
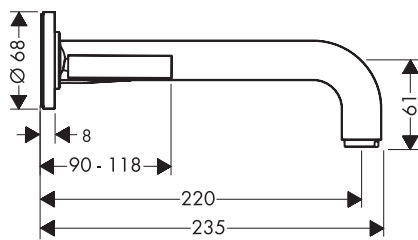



AXOR One
48120XXX

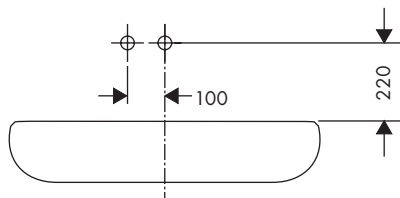
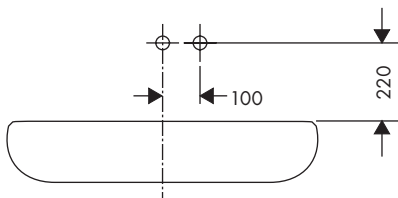
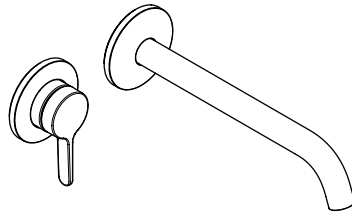
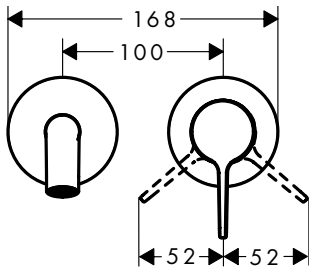
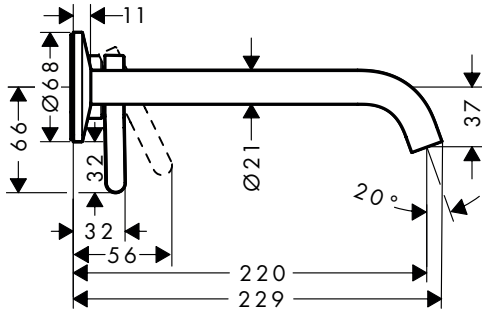



AXOR Uno
45112XXX

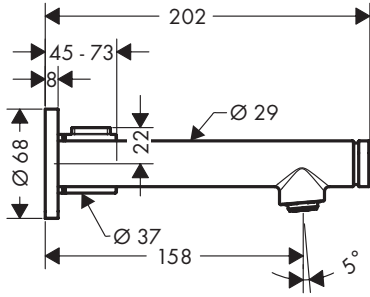

AXOR Uno
45113XXX

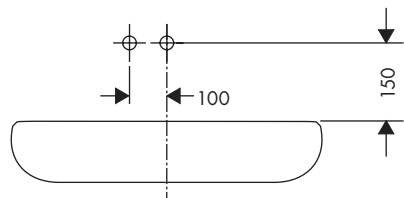
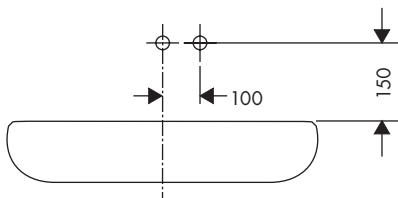
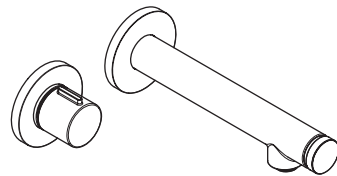
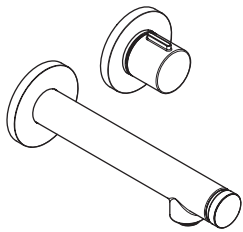
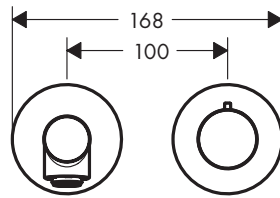
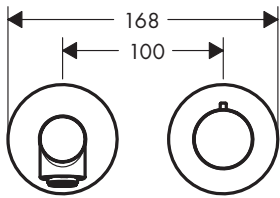
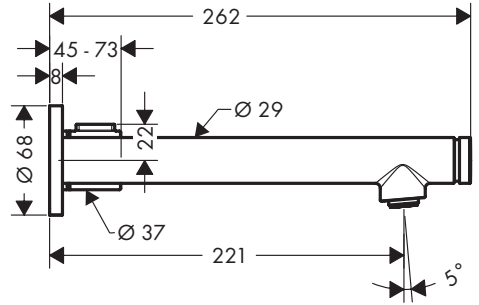



AXOR Citterio E
36106XXX

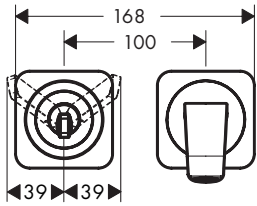
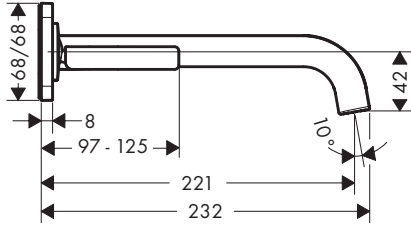

AXOR Citterio E
36114XXX

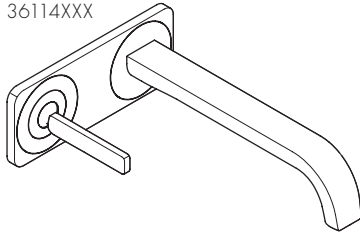

AXOR Citterio E
36114XXX

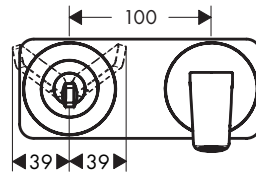
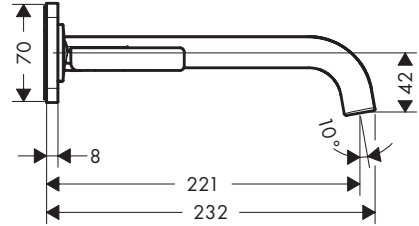

AXOR Citterio E
36114XXX

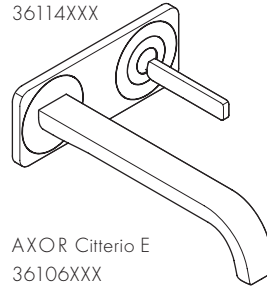

AXOR Citterio E
36106XXX

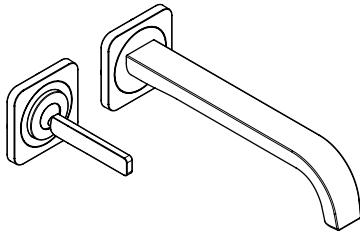

AXOR Citterio E
36106XXX

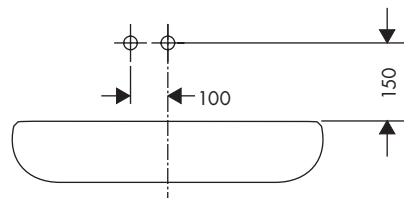
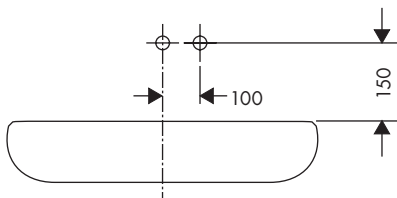
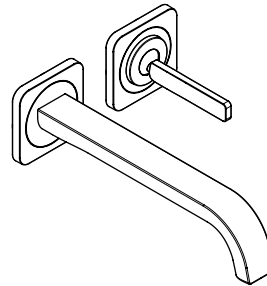



AXORUno
38815XXX

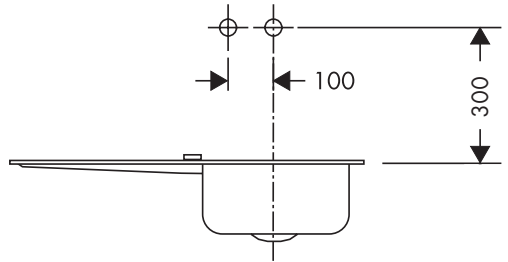
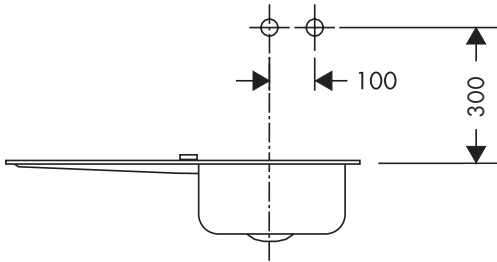
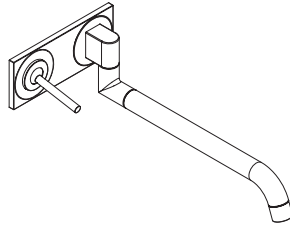
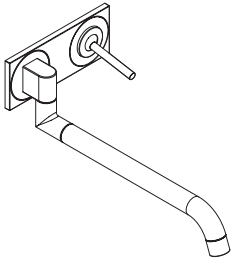
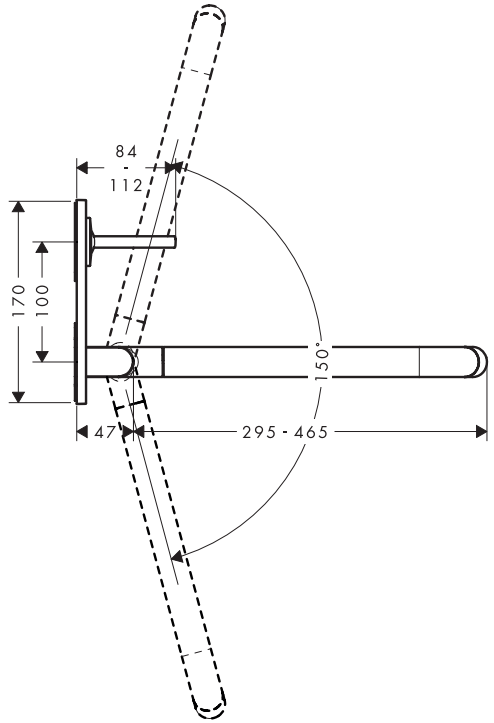
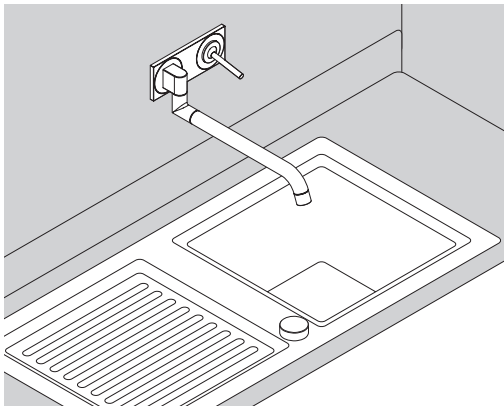
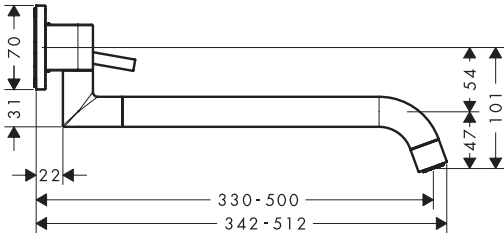



AXOR
13623180 / 13623187

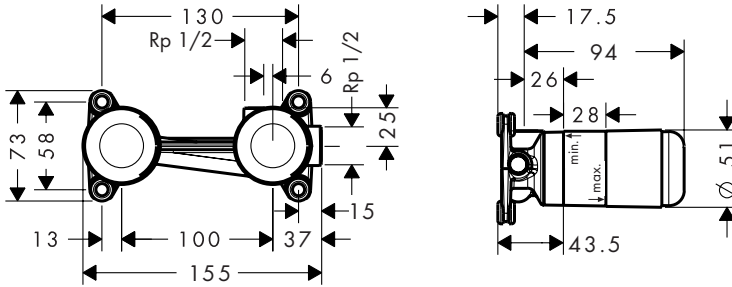

AXOR
13623180 / 13623187

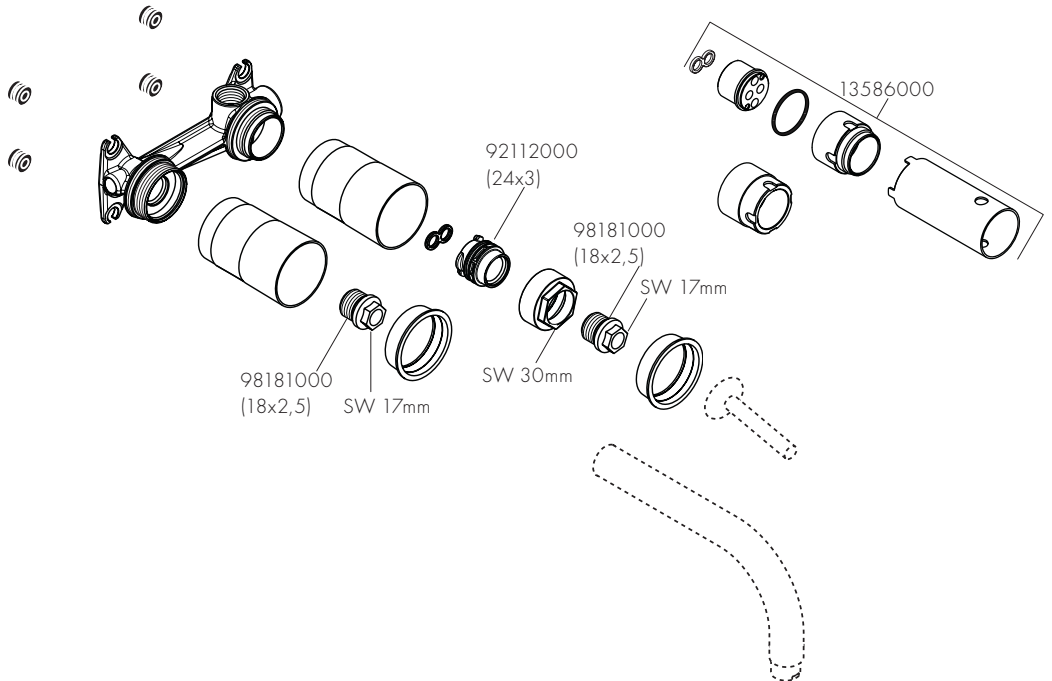

P-IX

DVGW

SINTEF

NF



ETA



GODKENDT
TIL DRILKEVAND



13623180

CQ0622

X

X

X

AXOR

AXOR / Hansgrohe SE
Austraße 5-9
77761 Schiltach
Deutschland

info@axor-design.com
axor-design.com

01/2022
911079.01