

Hansgrohe ComfortZone test

The right mixer for every washbasin. For satisfied customers.



Irritating water splashes due to mismatched combinations of mixer and washbasin – perhaps that’s something you’ve already experienced. As of now, your customers’ associated annoyance is a thing of the past.



Hansgrohe tested all the ComfortZone basin mixers with the leading manufacturers’ most popular washbasins in the ComfortZone test, its specially developed realistic test procedure. The space under the mixer and the splash behaviour are tested in this performance test of mixer and basin. You will find detailed information on the ComfortZone test at:

www.pro.hansgrohe-int.com/comfortzone-test

Ceramic types

You will always find the matching Hansgrohe mixer to go with the familiar basin types. The Hansgrohe ComfortZone test is a comprehensive guidance document for the perfect installation of the mixer and washbasin for pleasant, splash-free washing. Five different ceramic types were tested in the Hansgrohe ComfortZone test:

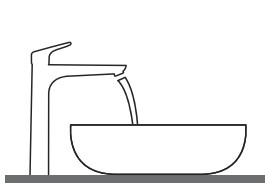

Washbasin with the mixer behind it

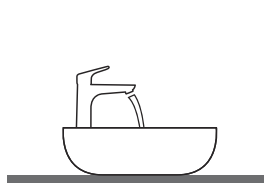

Washbasin with the mixer on top of it

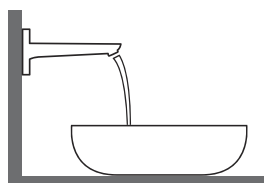

Washbasin with the mixer on the wall

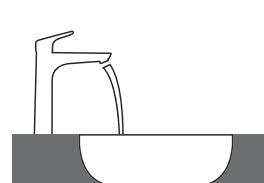

Undermount or top-mounted basin with free standing mixer

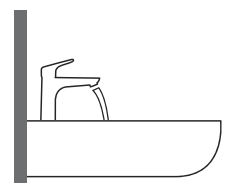

Wall-mounted washbasin with the mixer on it

You can use the results of the ComfortZone test free now. At: www.pro.hansgrohe-int.com/comfortzone-test

Instructions

The following explains just how easy it is to work with the results of the Hangrohe ComfortZone test.

Hangrohe ComfortZone mixer and item number
(different item numbers refer to different versions of waste systems)

Manufacturer and washbasin line

Washbasin with item number and details of size (different item numbers refer to different version of taphole and overflow versions)

Testergebnisse mit Duravit Waschbecken_EN.pdf - Adobe Acrobat Pro

File Edit View Window Help

Create [Icons]

12 / 14 99,5%

Search Tools Comment Sha

Bookmarks

- Introduction
- Duravit 2nd Floor
- Duravit New Darling
- Duravit Starck 3
- Duravit Vero

Which Hangrohe mixer suits which basin?

Duravit

	Vero	250x450	500x250	485x315	595x465	550x465	850x490	1050x490	1250x490	600x470	800x470	1000x470	1200x470	500x380	600x390
Metris		#070223.00	#070350.08	#070350.07	#070350.00	#033048.00	#033048.00	#033048.00	#033048.00	#033048.00	#033048.00	#033048.00	#033048.00	#033048.00	#033048.00
Metris 100		#31088000	✓	✓											
		#31166000	✓	✓											
Metris 110		#31080000	✓	✓	✓ b1	✓	✓	✓	✓	✓	✓	✓	✓	✓	✓
		#31121000	✓	✓	✓ b1	✓	✓	✓	✓	✓	✓	✓	✓	✓	✓
Metris 200		#31183000	✓	✓	✓ b1	✓	✓	✓	✓	✓	✓	✓	✓	✓	✓
		#31185000	✓	✓	✓ b1	✓	✓	✓	✓	✓	✓	✓	✓	✓	✓
Metris 230		#31087000	✓	✓	✓ b1	✓	✓	✓	✓	✓	✓	✓	✓	✓	✓
		#31187000	✓	✓	✓ b1	✓	✓	✓	✓	✓	✓	✓	✓	✓	✓
Metris 260		#31082000	✓	✓	✓ b2	✓	✓	✓	✓	✓	✓	✓	✓	✓	✓
		#31184000	✓	✓	✓ b2	✓	✓	✓	✓	✓	✓	✓	✓	✓	✓
Metris 165 mm		#31085000	✓	✓	✓ c1	✓	✓	✓	✓	✓	✓	✓	✓	✓	✓
Metris 225 mm		#31086000	✓	✓	✓ c3	✓	✓	✓	✓	✓	✓	✓	✓	✓	✓

Legend

Hansgrohe Test Center

Mounting dimensions for different installation situations

Tested recommended combinations

Information Washbasin type

Legend

- a1 = 35 mm
- a2 = 50 mm
- a3 = 100 mm
- b1 = 60 mm
- b2 = 100 mm
- c1 = 150 mm
- c2 = 220 mm
- d1 = 35 mm
- d2 = 60 mm
- d3 = 100 mm
- e1 = 35 mm
- e2 = 60 mm
- e3 = 100 mm

✓ = Recommended combination | ● = Taphole pushed through | ○ = Prepared taphole | ⊗ = without taphole

Bookmarks

- Introduction
- Duravit 2nd Floor
- Duravit New Darling
- Duravit Starck 3
- Duravit Vero











Search

Use the search field if you are looking for a specific item number or product name for a mixer or washbasin (key combination: Ctrl+f). This is the quickest way to your chosen product.

The table of contents makes it easy to get to your chosen ceramic line.

Which Hansgrohe mixer suits which basin?

Laufen

My Life									
		470 x 380		750 x 480		750 x 530		650 x 440	
		●	⊗	●	⊗	●	⊗	●	⊗
Metris		#815942/104	#815942/109	#811946/104	#811946/109	#810946/104	#810946/109	#818944/104	#818944/109
Metris 100									
	#31088000	✓							
Metris 110									
	#31080000 #31121000	✓		✓		✓		✓	
Metris 200									
	#31183000	✓		✓		✓		✓	
Metris 230									
	#31087000			✓ ^{a1}		✓		✓	
Metris 260									
	#31082000			✓ ^{a2}		✓		✓ ^{a1}	
Metris 165 mm									
	#31085000		✓ ^{c1}						✓ ^{c1} _{d1}
Metris 225 mm									
	#31086000		✓ ^{c1}	✓ ^{c1} _{d1}		✓ ^{c1}		✓ ^{c1} _{d2}	



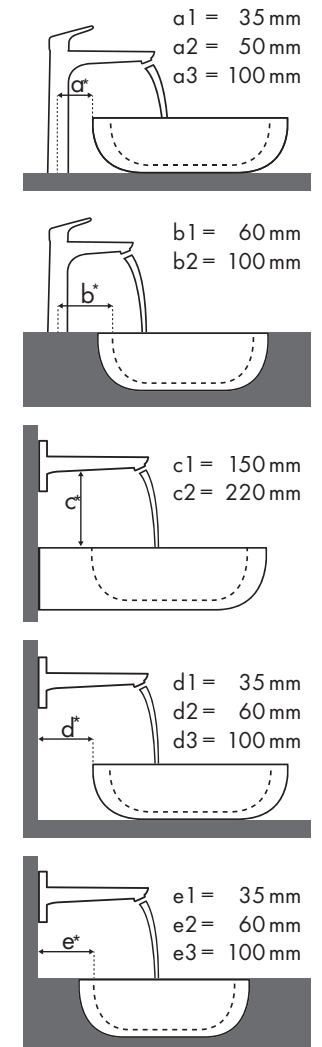

Legend



Which Hansgrohe mixer suits which basin?

Laufen

My Life									
		470 x 380		750 x 480		750 x 530		650 x 440	
		●	⊗	●	⊗	●	⊗	●	⊗
Talis		#815942/104	#815942/109	#811946/104	#811946/109	#810946/104	#810946/109	#818944/104	#818944/109
Talis 80		#32040000 #32057000	✓	✓	✓	✓	✓	✓	✓
Talis 80		#32053000		✓	✓	✓	✓		
Talis 150		#32052000				✓			
Talis S²		#32070000 #32073000		✓	✓	✓	✓		
Talis 210		#32084000		✓	✓	✓	✓		
Talis 250		#32055000				✓			
Talis 165 mm		#31618000	✓ ^{c1}						✓ ^{c1} _{d1}
Talis 225 mm		#31611000	✓ ^{c1}	✓ ^{c1} _{d1}	✓ ^{c1}	✓ ^{c1}	✓ ^{c1}	✓ ^{c1}	✓ ^{c1} _{d2}

✓ = Recommended combination | ● = Taphole pushed through | ○ = Prepared taphole | ⊗ = Without taphole





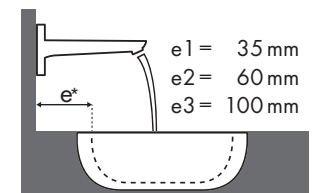
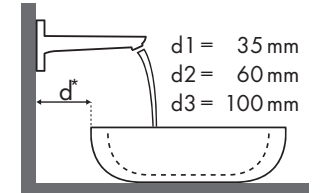
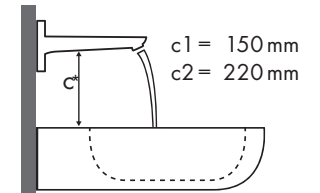
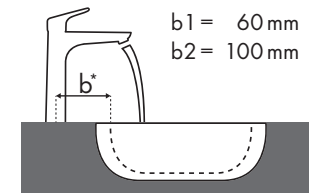
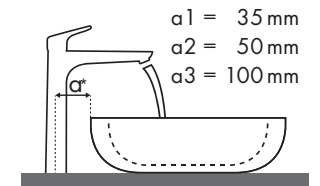





Legend



Which Hansgrohe mixer suits which basin?

Laufen

My Life					
		470 x 380	750 x 480	750 x 530	650 x 440
		● #815942/104	● #811946/104	● #810946/104	● #818944/104
Focus 70	 #31730000	✓			
Focus 100	 #31607000 #31621000	✓	✓	✓	✓
Focus 190	 #31608000	✓	✓	✓	✓
Focus 240	 #31609000			✓	✓





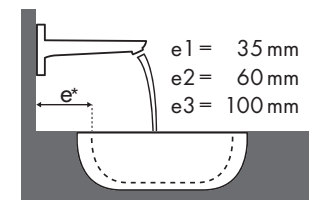
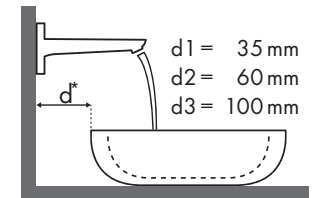
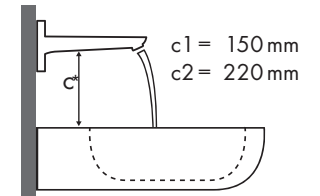
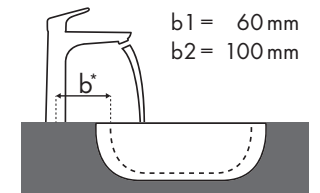
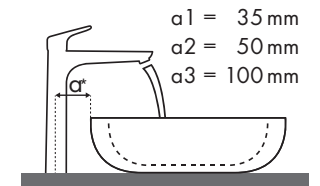



Legend



Which Hansgrohe mixer suits which basin?

Laufen

My Life									
		470 x 380		750 x 480		750 x 530		650 x 440	
		●	⊗	●	⊗	●	⊗	●	⊗
PuraVida		#815942/104	#815942/109	#811946/104	#811946/109	#810946/104	#810946/109	#818944/104	#818944/109
PuraVida 100 	#15075000 #15075400	✓							
	#15132000 #15132400	✓							
PuraVida 110 	#15070000 #15070400	✓		✓		✓		✓	
	#15072000 #15072400 #15066000 #15066400		✓ ^{c1}	✓ ^{c1}		✓ ^{c1}		✓ ^{c1} ✓ ^{d2}	
PuraVida 225 mm 	#15084000 #15084400		✓ ^{c1}	✓ ^{c1}		✓ ^{c1}		✓ ^{c1} ✓ ^{d2}	





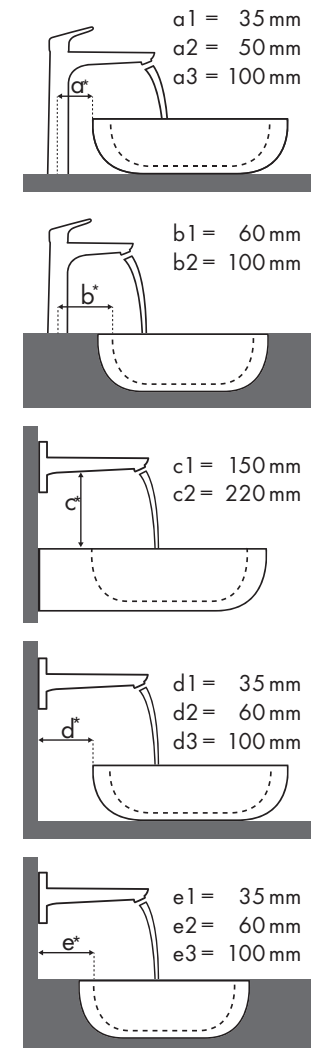





Legend



Which Hansgrohe mixer suits which basin?

Laufen

My Life									
		470 x 380		750 x 480		750 x 530		650 x 440	
		●	⊗	●	⊗	●	⊗	●	⊗
Metris Classic		#815942/104	#815942/109	#811946/104	#811946/109	#810946/104	#810946/109	#818944/104	#818944/109
Metris Classic 100	#31075000			✓		✓		✓	
	#31077000	✓							
Metris Classic 250	#31078000			✓ ^{a2}		✓			✓ ^{a2}
									
Metris Classic 165 mm	#31000000		✓ ^{c1}		✓ ^{d1}				✓ ^{d1}
									
Metris Classic 225 mm	#31003000		✓ ^{c1}		✓ ^{d1}		✓ ^{c1}		✓ ^{d2}
									





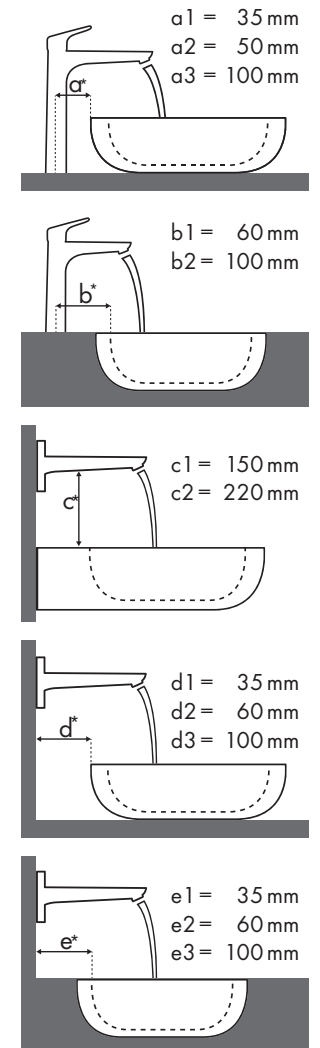



Legend



Which Hansgrohe mixer suits which basin?

Laufen

My Life									
		470 x 380		750 x 480		750 x 530		650 x 440	
		●	⊗	●	⊗	●	⊗	●	⊗
Talis Classic		#815942/104	#815942/109	#811946/104	#811946/109	#810946/104	#810946/109	#818944/104	#818944/109
Talis Classic 80 	#14111000			✓		✓		✓	
	#14118000	✓							
Talis Classic 90 	#14127000			✓		✓		✓	
Talis Classic 230 	#14116000				✓ ^{a2}	✓			✓ ^{a2}





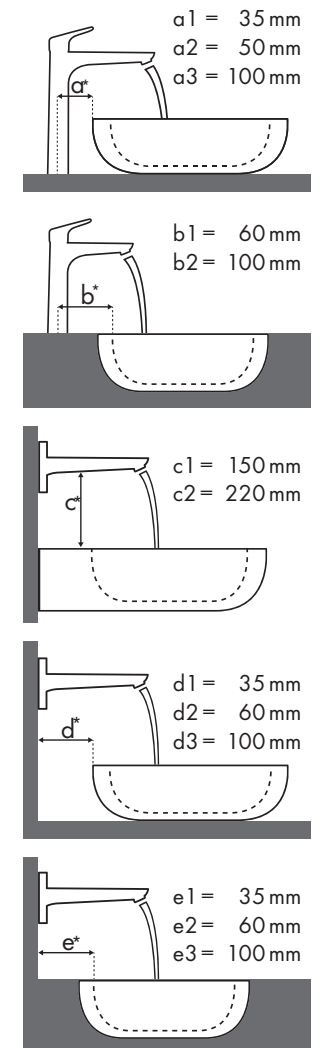









Legend



Which Hansgrohe mixer suits which basin?

Laufen

Pro														
	450 x 340				525 x 400	625 x 400	600 x 380		850 x 480	1050 x 480	600 x 400			
	● #811951/104 #811952/104	● #811951/156	⊗ #811951/109 #811952/109	⊗ #811951/142	⊗ #811961/109 #811961/155	⊗ #811969/109 #811969/155	● #812953/104	● #812953/156	⊗ #812953/109	⊗ #812953/142	● #813956/104	⊗ #813956/109	● #813958/104	⊗ #813958/109
Metris														
Metris 100 	# 31088000	✓												
	# 31166000	✓	✓											
Metris 110 	# 31080000 # 31121000	✓			✓b1	✓b1	✓			✓		✓		
	# 31084000	✓	✓		✓b1	✓b1	✓	✓		✓		✓		
Metris 200 	# 31183000				✓b1	✓b1	✓			✓		✓		
	# 31185000				✓b1	✓b1	✓	✓		✓		✓		✓a2
Metris 230 	# 31087000 # 31187000				✓b1	✓b1				✓		✓		
	# 31081000				✓b1	✓b1				✓		✓		
Metris 260 	# 31082000				✓b1	✓b1								
	# 31184000				✓b1	✓b1								✓a2
Metris 165 mm 	# 31085000		✓c1	✓c1	✓c1 e2	✓c1 e2		✓c1	✓c1					✓c1 d2
Metris 225 mm 	# 31086000				✓c1 e2	✓c1 e2		✓c1	✓c1	✓c1		✓c1		✓c1 d2





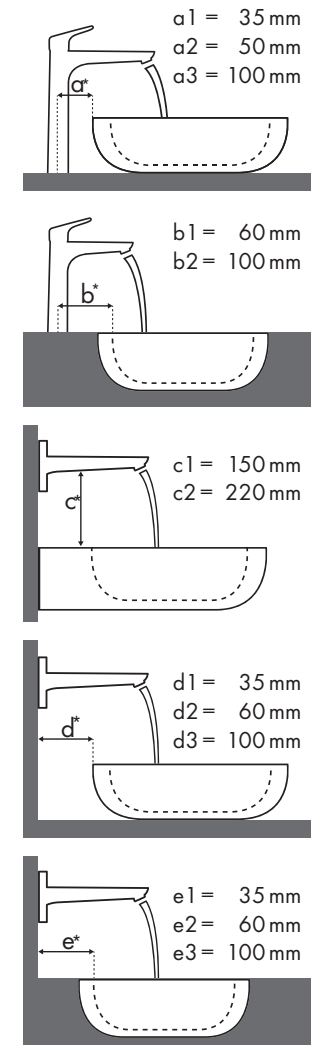









Legend



Which Hansgrohe mixer suits which basin?

Laufen

Pro											
		450 x 340		525 x 400	625 x 400	600 x 380		850 x 480	1050 x 480	600 x 400	
		●	○	○	○	○	○	○	○	○	○
Talis		#811951/104 #811952/104	#811951/156 #811951/109 #811952/109	#811951/142	#811961/109 #811961/155	#811969/109 #811969/155	#812953/104 #812953/156 #812953/109 #812953/142	#813956/104 #813956/109	#813958/104 #813958/109	#816952/112	
Talis 80 	#32040000 #32057000 #32041000 #32130000	✓					✓		✓		
Talis 80 	#32053000						✓		✓		
Talis 150 	#32052000				✓ _{b1}	✓ _{b1}			✓	✓	
Talis S² 	#32070000 #32073000				✓ _{b1}	✓ _{b1}	✓		✓	✓	
Talis 210 	#32084000 #32082000 #32080000				✓ _{b1}	✓ _{b1}	✓		✓	✓	
Talis 250 	#32055000				✓ _{b1}	✓ _{b1}			✓	✓	
Talis 165 mm 	#31618000		✓ _{c1}	✓ _{c1}	✓ _{e2} ^{c1}	✓ _{e2} ^{c1}		✓ _{c1}	✓ _{c1}		✓ _{d2} ^{c1}
Talis 225 mm 	#31611000				✓ _{e2} ^{c1}	✓ _{e2} ^{c1}		✓ _{c1}	✓ _{c1}	✓ _{c1}	✓ _{d2} ^{c1}

✓ = Recommended combination | ● = Taphole pushed through | ○ = Prepared taphole | ⊗ = Without taphole





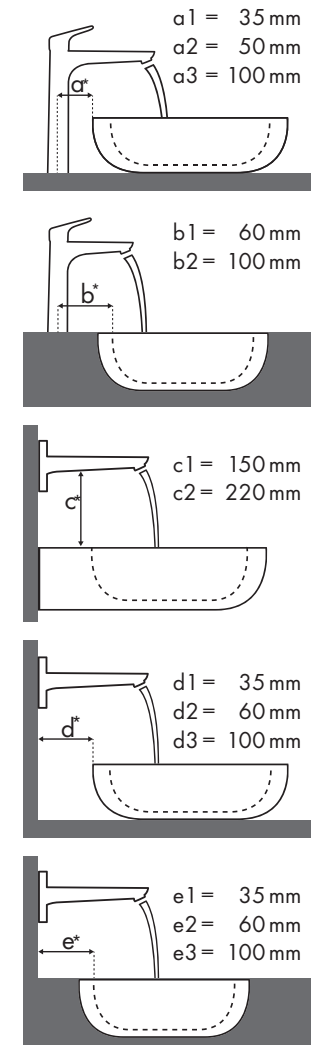





Legend



Which Hansgrohe mixer suits which basin?

Laufen

Pro										
		450 x 340		525 x 400	625 x 400	600 x 380		850 x 480	1050 x 480	600 x 400
		● #811951/104 #811952/104	● #811951/156	⊗ #811961/109 #811961/155	⊗ #811969/109 #811969/155	● #812953/104	● #812953/156	● #813956/104	● #813958/104	⊗ #816952/112
Focus 70 	# 31730000	✓								
	# 31733000 # 31130000	✓	✓							
	# 31607000 # 31621000	✓		✓b1	✓b1	✓		✓	✓	
Focus 100 	# 31517000	✓	✓	✓b1	✓b1	✓	✓	✓	✓	
	# 31608000			✓b1	✓b1	✓		✓	✓	
Focus 190 	# 31518000			✓b1	✓b1	✓	✓	✓	✓	✓a2
	# 31609000			✓b1	✓b1			✓	✓	
Focus 240 	# 31519000			✓b1	✓b1			✓	✓	





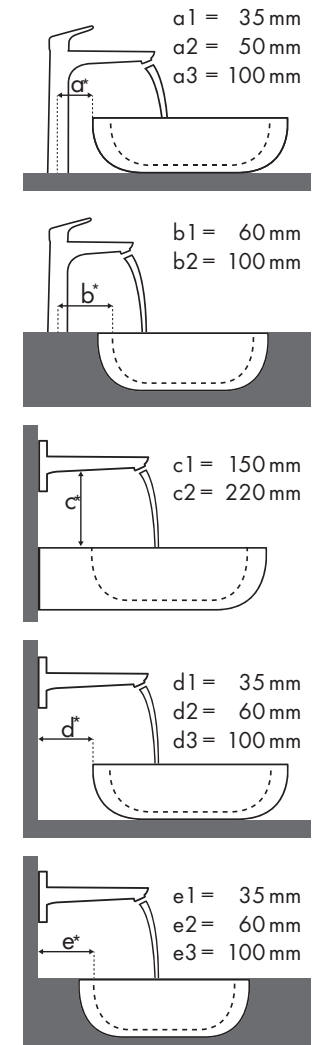





Legend



Which Hansgrohe mixer suits which basin?

Laufen

Pro											
		450 x 340		525 x 400	625 x 400	600 x 380		850 x 480	1050 x 480		600 x 400
		● #811951/104 #811952/104	● #811951/156	⊗ #811951/109 #811952/109	⊗ #811961/109 #811961/155	⊗ #811969/109 #811969/155	● #812953/104 #812953/156	⊗ #812953/109 #812953/142	● #813956/104 #813956/109	● #813958/104 #813958/109	⊗ #813958/109
PuraVida 100 	#15075000 #15075400	✓	✓					✓	✓		
	#15132000 #15132400	✓	✓					✓	✓		
PuraVida 110 	#15070000 #15070400	✓	✓		✓ ^{b1}	✓ ^{b1}	✓	✓		✓	✓
	#15074000 #15074400	✓			✓ ^{b1}	✓ ^{b1}	✓			✓	
PuraVida 200 	#15081000 #15081400				✓ ^{b1}	✓ ^{b1}	✓			✓	✓ ^{a2}
	#15072000 #15072400 #15066000 #15066400				✓ ^{b1}	✓ ^{b1}				✓	✓ ^{a2}
PuraVida 165 mm 	#15084000 #15084400		✓ ^{c1}	✓ ^{c1}	✓ ^{c1} ✓ ^{e2}	✓ ^{c1} ✓ ^{e2}		✓ ^{c1}	✓ ^{c1}	✓ ^{c1}	✓ ^{c1} ✓ ^{d2}
	#15085000 #15085400		✓ ^{c1}	✓ ^{c1}	✓ ^{c1} ✓ ^{e2}	✓ ^{c1} ✓ ^{e2}		✓ ^{c1}	✓ ^{c1}	✓ ^{c1}	✓ ^{c1} ✓ ^{d2}



Legend

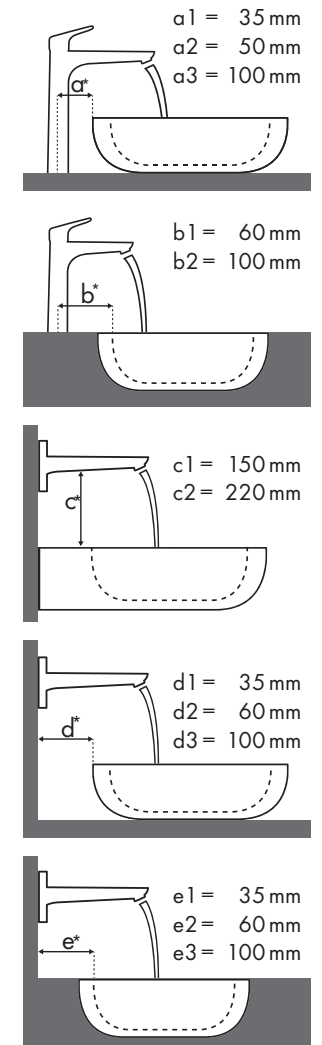

✓ = Recommended combination | ● = Taphole pushed through | ○ = Prepared taphole | ⊗ = Without taphole

Which Hansgrohe mixer suits which basin?

Laufen

Pro																				
		450 x 340		525 x 400		625 x 400		600 x 380		850 x 480		1050 x 480		600 x 400						
		●	○	●	○	●	○	●	○	●	○	●	○	●	○	●	○			
Metris Classic		●	○	●	○	●	○	●	○	●	○	●	○	●	○					
		#811951/104	#811952/104	#811951/156	#811951/109	#811952/109	#811951/142	#811961/109	#811961/155	#811969/109	#811969/155	#812953/104	#812953/156	#812953/109	#812953/142	#813956/104	#813956/109	#813958/104	#813958/109	#816952/112
Metris Classic 100	#31075000	✓				✓ ^{b1}	✓ ^{b1}	✓				✓				✓				
	#31077000	✓	✓			✓ ^{b1}	✓ ^{b1}	✓	✓			✓				✓				
Metris Classic 250	#31078000					✓ ^{b1}	✓ ^{b1}					✓		✓						✓ ^{a2}
Metris Classic 165 mm	#31000000			✓ ^{c1}	✓ ^{c1}	✓ ^{c1}	✓ ^{e2}	✓ ^{c1}	✓ ^{e2}			✓ ^{c1}	✓ ^{c1}	✓ ^{c1}	✓ ^{c1}	✓ ^{c1}	✓ ^{c1}	✓ ^{c1}	✓ ^{d2}	✓ ^{c1}
Metris Classic 225 mm	#31003000			✓ ^{c1}	✓ ^{c1}	✓ ^{c1}	✓ ^{e2}	✓ ^{c1}	✓ ^{e2}			✓ ^{c1}	✓ ^{c1}	✓ ^{c1}	✓ ^{c1}	✓ ^{c1}	✓ ^{c1}	✓ ^{c1}	✓ ^{d2}	✓ ^{c1}



Legend

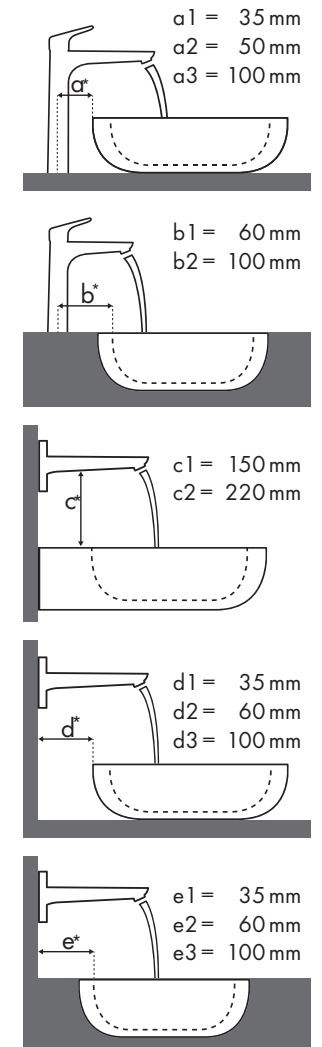

Which Hansgrohe mixer suits which basin?

Laufen

Pro																					
		450 x 340				525 x 400	625 x 400	600 x 380				850 x 480	1050 x 480	600 x 400							
		●	●	⊗	⊗	⊗	⊗	●	●	⊗	⊗	●	⊗	●	⊗	⊗					
Talis Classic		#811951/104	#811952/104	#811951/156	#811951/109	#811952/109	#811951/142	#811961/109	#811961/155	#811969/109	#811969/155	#812953/104	#812953/156	#812953/109	#812953/142	#813956/104	#813956/109	#813958/104	#813958/109	#816952/112	
	#14111000	✓										✓									
	#14118000	✓	✓									✓	✓								
	#14127000	✓						✓ ^{b1}	✓ ^{b1}	✓						✓		✓			
	#14116000							✓ ^{b1}	✓ ^{b1}							✓		✓			✓ ^{a2}



Legend

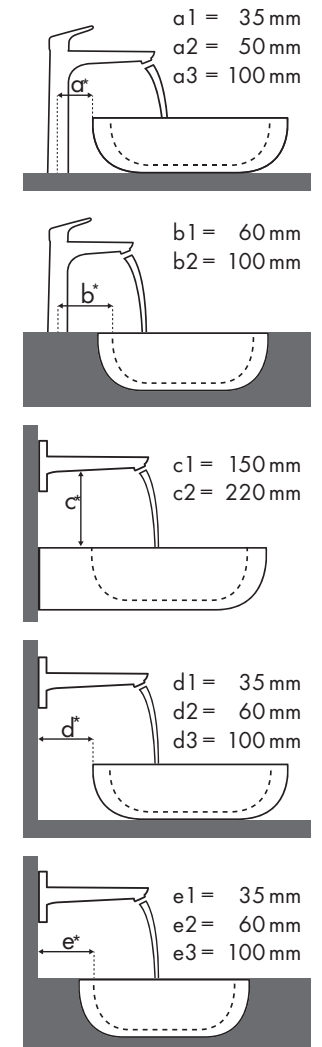

✓ = Recommended combination | ● = Taphole pushed through | ○ = Prepared taphole | ⊗ = Without taphole